

# BLUE RHINO CENTRIFUGAL FANS: SWSI

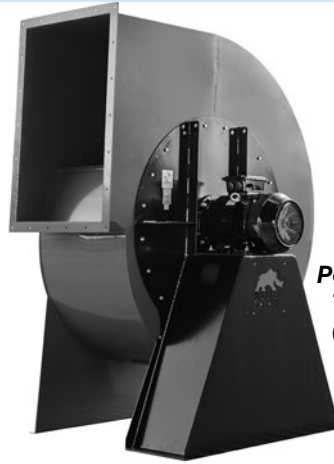

**Box Type (BRB)**



**Pedestal Type (BRP)**



**High Pressure Type (BRH)**

## DESCRIPTION

The Blue Rhino range of single width, single inlet (SWSI) centrifugal fans features a backward-curved laminar impeller and a heavy duty, fully welded construction.

The Blue Rhino is intended to be used with a Variable Speed Drive (VSD) to achieve the desired speed, eliminating the need for a high maintenance belt and pulley system. They are driven by a direct drive motor and are available with a durable blue powder coating by default or selected with a long-lasting hot dip galvanised finish.

The range is available in 19 impeller sizes, extending from 12 inch (305mm) to 44 inch (1120mm) diameter. There are three housing designs available to suit a wide range of duties.

## Typical Applications

Designed for a wide range of supply or exhaust air applications such as shopping centres, food halls and car parks.

## Features

- Casings and impellers are made of high strength fully welded mild steel.
- VSD which eliminates the need for high maintenance belt and pulley system.
- VSD can be factory pre-configured to suit application, creating a time saving plug and play system.
- Fitted with inlet spigot and discharge flange.
- Comes standard with inspection hatches and drain plugs.
- Clockwise impeller rotation is standard, anti-clockwise rotation is available upon request.
- Driven by a reliable direct drive motor design.
- Comes with a durable blue powder coating by default. Alternatively, it can be selected with a long-lasting hot dip galvanised finish.

### BRB - Box Type

- Available in impeller diameter sizes from 12 to 30 inch
- Efficient and compact design
- Can be rotated onsite to 0, 90 or 180° position to suit installation requirements

### BRP - Pedestal Type

- Available in impeller diameter sizes from 27 to 44 inch
- Available in 0, 90 or 180° discharge angles

### BRH - High Pressure Type

- Available in impeller diameters sizes from 12 to 24 inch
- Available in 0, 90, 180° discharge angles

## Construction

Fully welded mild steel casings  
Hot dip galvanised or blue powder coated finish  
Impellers are fully welded  
Backward-curved laminar impeller

## Motors

Type - standard TEFC squirrel cage induction motors  
Electricity supply - three-phase to suit a wide range of voltages and frequencies.

## Internal thermal Protection

Thermistors can be provided.

## Testing

Based on air flow tests to ISO5801: 2007

## Wiring Diagram

See page N-6, diagrams DD 1, 2, 3.

## Special Note

The quick-selection graphs on the following pages are designed to give a close indication of the fan size required to perform the specified duty. Detailed selections can be determined using the Fantech Product Selection Program, or by referring to a Fantech sales engineer.

## SUGGESTED SPECIFICATION

The single width, single inlet (SWSI) centrifugal fans shall be of the Blue Rhino series as designed and manufactured by Fantech Pty. Ltd. and be of the model numbers shown on the schedule/drawing. The housings and impellers shall be made from fully welded mild steel with a blue powder coating or hot dip galvanised finish. Impellers shall be backward-curved laminar design, rotating clockwise unless specified otherwise. They shall be driven by a direct drive motor and designed to operate with a Variable Speed Drive which can be factory pre-configured to suit the application. They shall be fitted with inlet spigot and discharge flange, and come standard with inspection hatches and drain plugs. Air flow data shall be based on tests to ISO5801:2007.

## HOW TO ORDER

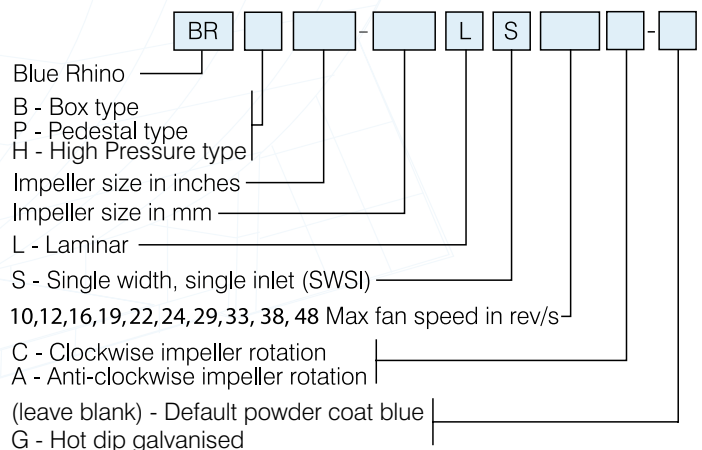

Please provide the following additional information so that your order can be processed promptly:

- Discharge angle (Pedestal and High Pressure range only):  
0 degree, 90 degree or 180 degree

# BLUE RHINO CENTRIFUGAL FANS: SWSI

## PERFORMANCE CURVES - BRB BOX TYPE

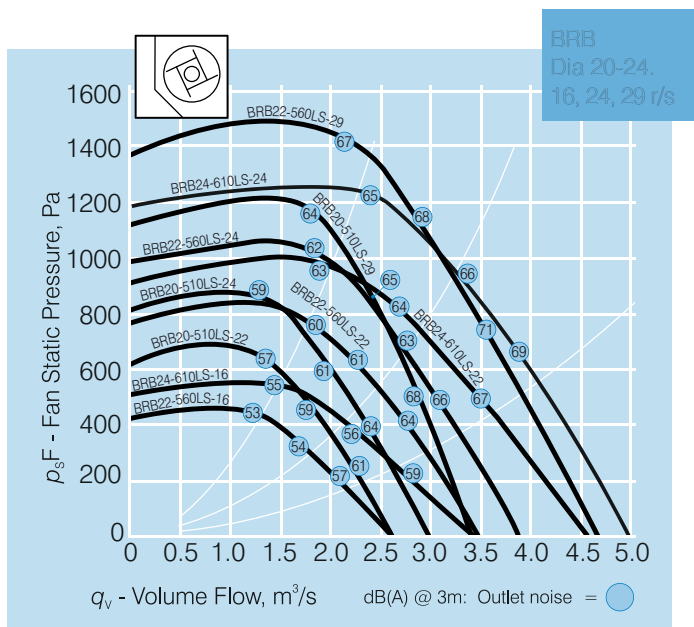
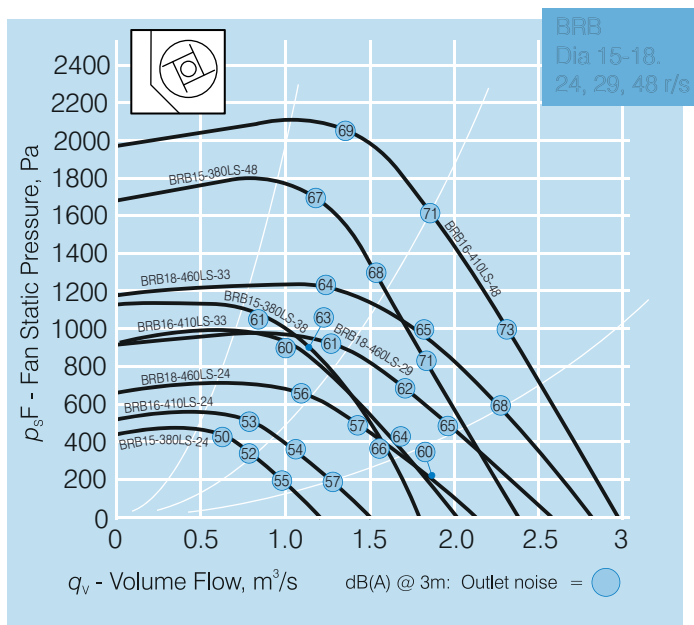
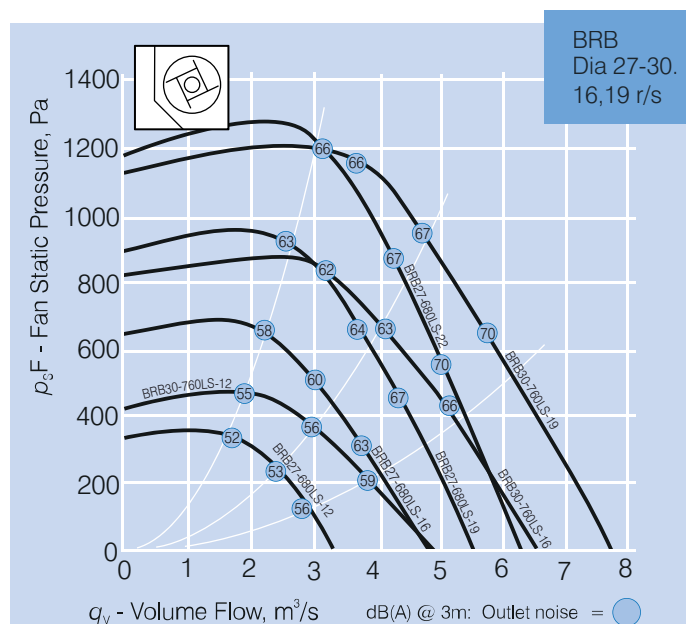
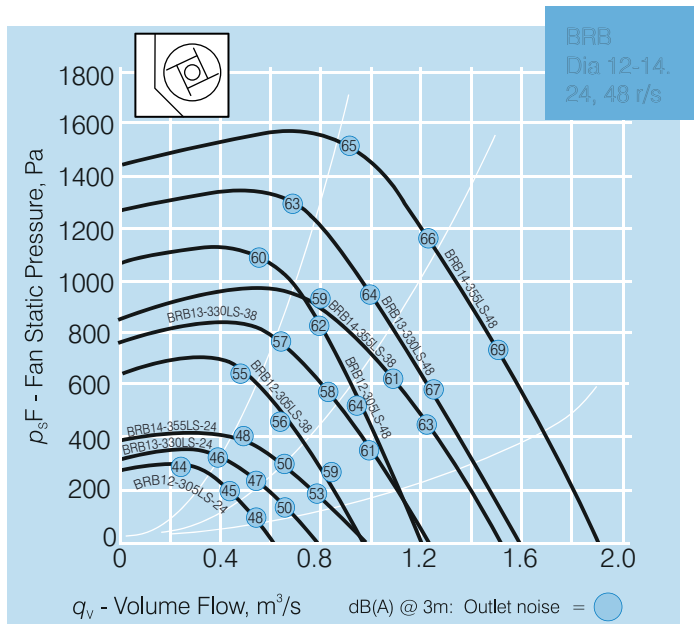

## TECHNICAL DATA - BRB BOX TYPE

Model Number BRB..	Max. Speed rev/sec	Max Amps	Motor kW
12-305LS-24	24	1.6	0.55
12-305LS-38	38	1.5	0.75*
12-305LS-48	48	2.4	1.1
13-330LS-24	24	1.6	0.55
13-330LS-38	38	2.2	1.1*
13-330LS-48	48	4.6	2.2
14-355LS-24	24	1.6	0.55
14-355LS-38	38	2.9	1.5*
14-355LS-48	48	5.8	3.0
15-380LS-24	24	1.6	0.55
15-380LS-38	38	4.3	2.2*
15-380LS-48	48	7.6	4.0
16-410LS-24	24	2.1	0.75
16-410LS-33	33	2.9	1.5*
16-410LS-48	48	10.5	5.5
18-460LS-24	24	3.4	1.5
18-460LS-29	29	4.3	2.2*
18-460LS-33	33	5.7	3.0*
20-510LS-22	22	3.2	1.5*
20-510LS-24	24	4.7	2.2
20-510LS-29	29	8.2	4.0*
22-560LS-16	16	3	1.1
22-560LS-22	22	4.7	2.2*
22-560LS-24	24	8.4	4.0
22-560LS-29	24	10.6	5.5*
24-610LS-16	16	3.9	1.5
24-610LS-22	22	8.2	4.0*
24-610LS-24	24	11	5.5
27-680LS-12	12	3.5	1.1
27-680LS-16	16	7.6	3.0
27-680LS-19	19	8.2	4.0*
27-680LS-22	22	14.3	7.5*
30-760LS-12	12	6.1	2.2
30-760LS-16	16	12.9	5.5
30-760LS-19	19	15.4	7.5*

\* Requires VSD - Cannot be run direct online (DOL).

# BLUE RHINO CENTRIFUGAL FANS: SWSI

## DIMENSIONS - BRB BOX TYPE

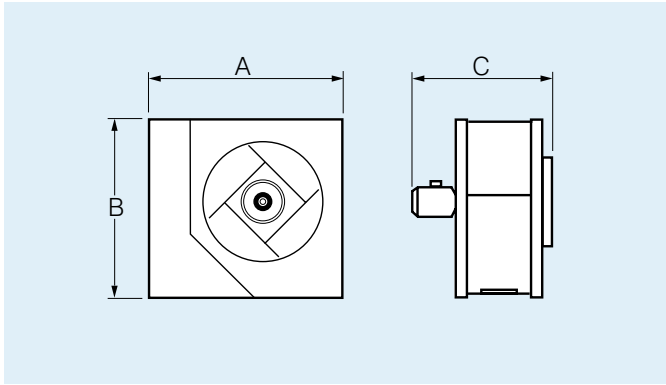

Model Number BRB..	Dimensions, mm			App. wt. kg
	A	B	C	
12-305LS-24	682	603	564	78
12-305LS-38	682	603	564	76
12-305LS-48	682	603	564	78
13-330LS-24	733	651	582	87
13-330LS-38	733	651	598	87
13-330LS-48	733	651	622	97
14-355LS-24	784	699	600	96
14-355LS-38	784	699	661	102
14-355LS-48	784	699	675	116
15-380LS-24	835	747	640	106
15-380LS-38	835	747	730	116
15-380LS-48	835	747	748	139
16-410LS-24	900	809	681	139
16-410LS-33	900	809	836	144
16-410LS-48	900	809	836	194
18-460LS-24	1020	908	744	190
18-460LS-29	1020	908	779	200
18-460LS-33	1020	908	808	198
20-510LS-22	1122	1004	851	222
20-510LS-24	1122	1004	835	231
20-510LS-29	1122	1004	855	250
22-560LS-16	1224	1100	838	255
22-560LS-22	1224	1100	902	264
22-560LS-24	1224	1100	902	283
22-560LS-29	1224	1100	993	295
24-610LS-16	1335	1196	909	307
24-610LS-22	1335	1196	994	328
24-610LS-24	1335	1196	1025	345
27-680LS-12	1473	1330	1022	369
27-680LS-16	1473	1330	1069	399
27-680LS-19	1473	1330	1109	411
27-680LS-22	1473	1330	1143	423
30-760LS-12	1640	1483	1162	500
30-760LS-16	1640	1483	1167	521
30-760LS-19	1640	1483	1224	539

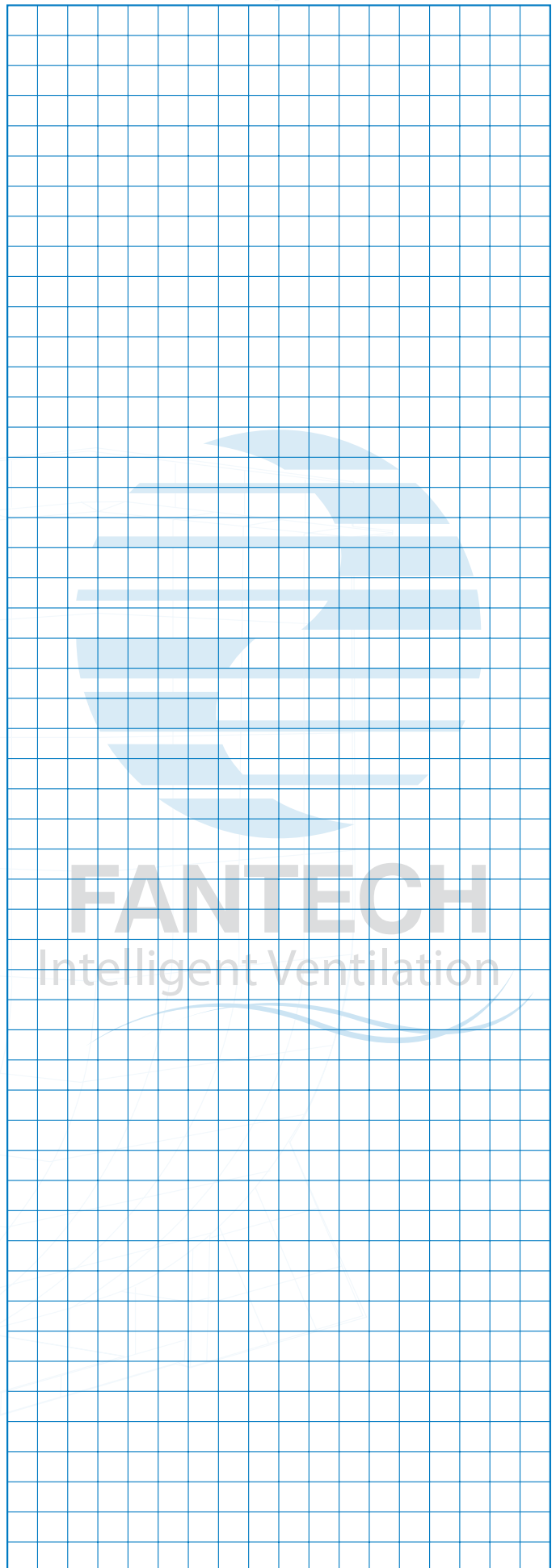

Scan the QR Code  
to view more  
information online.



**Box Type**

## PERFORMANCE CURVES - BRP PEDESTAL TYPE

## TECHNICAL DATA - BRP PEDESTAL TYPE

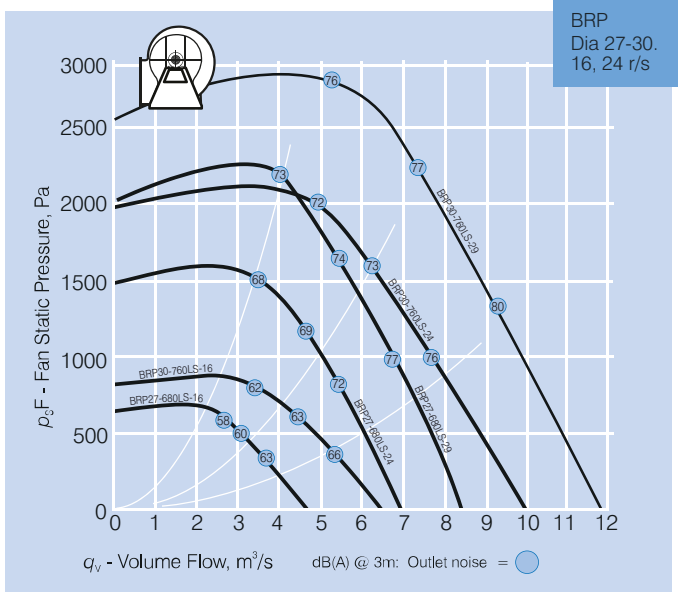

Model Number BRP..	Max. Speed rev/sec	Max Amps	Motor kW
27-680LS-16	16	7.6	3.0
27-680LS-24	24	21.5	11.0
27-680LS-29	29	27.6	15.0*
30-760LS-16	16	12.9	5.5
30-760LS-24	24	29.1	15.0
30-760LS-29	29	53	30.0*
33-840LS-12	12	7.9	3.0
33-840LS-16	16	16	7.5
33-840LS-22	22	32.8	18.5*
33-840LS-24	24	56.9	30.0
36-920LS-10	10	7	3.0*
36-920LS-12	12	14.7	5.5
36-920LS-16	16	23.4	11.0
36-920LS-22	22	53	30.0*
36-920LS-24	24	66.6	37.0
40-1020LS-10	10	12.8	5.5*
40-1020LS-12	12	17.7	7.5
40-1020LS-16	16	37.1	18.5
44-1120LS-10	10	16.4	7.5*
44-1120LS-12	12	34.3	15.0
44-1120LS-16	16	55	30.0

\* Requires VSD - Cannot be run direct online (DOL).

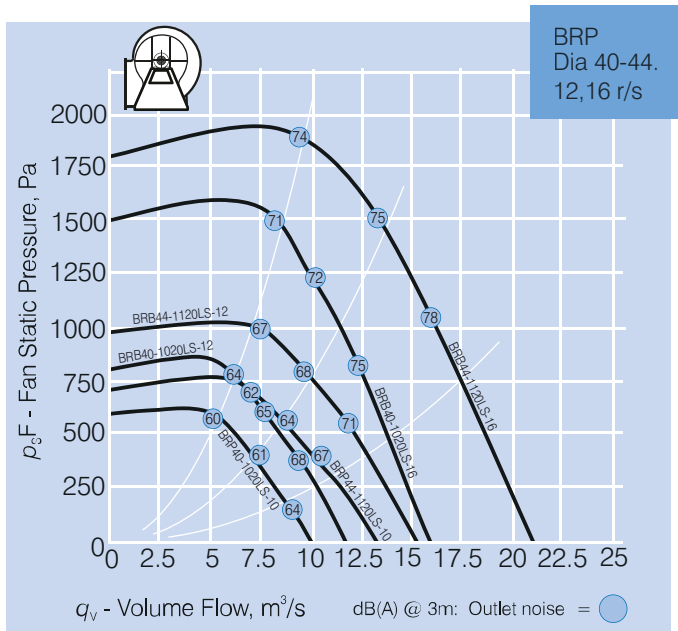
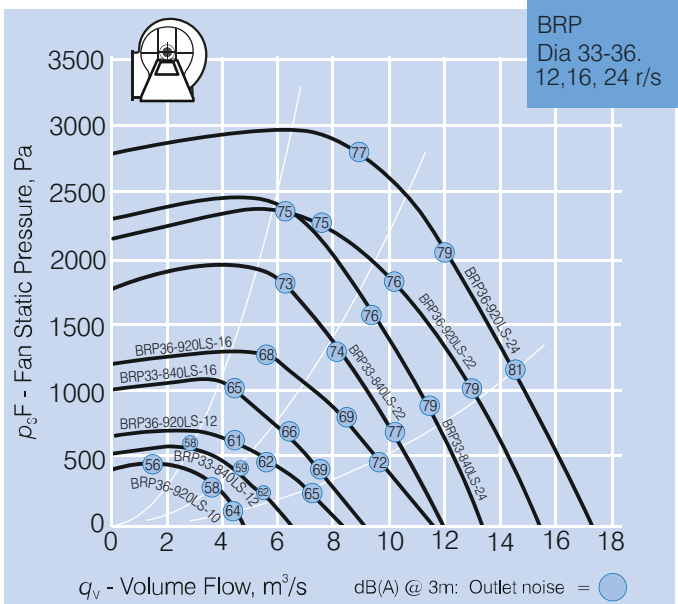

# BLUE RHINO CENTRIFUGAL FANS: SWSI

## DIMENSIONS - BRP PEDESTAL TYPE

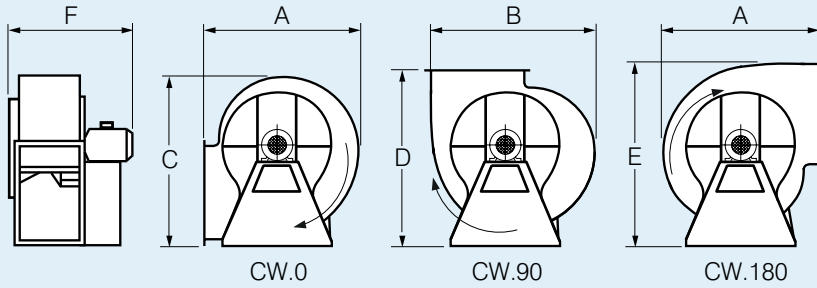

### Direction of Rotation & Discharge Position

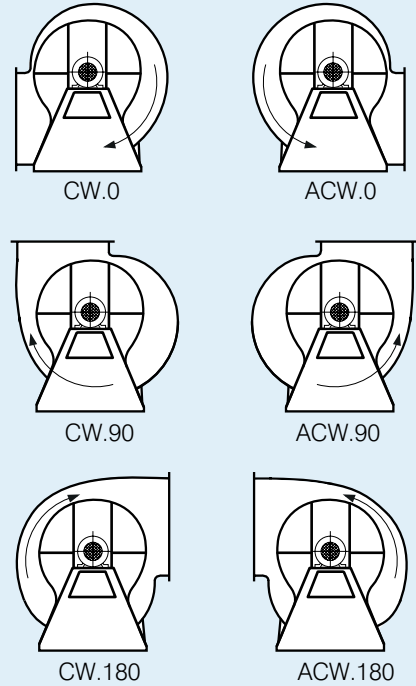

Model Number BRP..	Dimensions, mm						App. wt. kg
	A	B	C	D	E	F	
27-680LS-16	1314	1435	1436	1467	1699	1096	404
27-680LS-24	1314	1435	1436	1467	1699	1175	462
27-680LS-29	1314	1435	1436	1467	1699	1175	479
30-760LS-16	1467	1598	1605	1639	1893	1165	518
30-760LS-24	1467	1598	1605	1639	1893	1310	580
30-760LS-29	1467	1598	1605	1639	1893	1402	684
33-840LS-12	1621	1776	1774	1811	2102	1215	634
33-840LS-16	1621	1776	1774	1811	2102	1338	674
33-840LS-22	1621	1776	1774	1811	2102	1360	725
33-840LS-24	1624	1776	1774	1811	2102	1462	795
36-920LS-10	1773	1938	1943	1983	2295	1335	734
36-920LS-12	1773	1938	1943	1983	2295	1353	768
36-920LS-16	1773	1938	1943	1983	2295	1457	797
36-920LS-22	1773	1938	1943	1983	2295	1521	905
36-920LS-24	1773	1938	1943	1983	2295	1574	949
40-1020LS-10	1965	2141	2139	2183	2522	1445	908
40-1020LS-12	1965	2141	2139	2183	2522	1494	983
40-1020LS-16	1965	2141	2139	2183	2522	1596	1027
44-1120LS-10	2156	2344	2345	2393	2759	1574	1079
44-1120LS-12	2156	2344	2345	2393	2759	1670	1206
44-1120LS-16	2156	2344	2345	2393	2759	1722	1249



Scan the QR Code to view more information online.



**Pedestal Type**

## PERFORMANCE CURVES - BRH HIGH PRESSURE TYPE

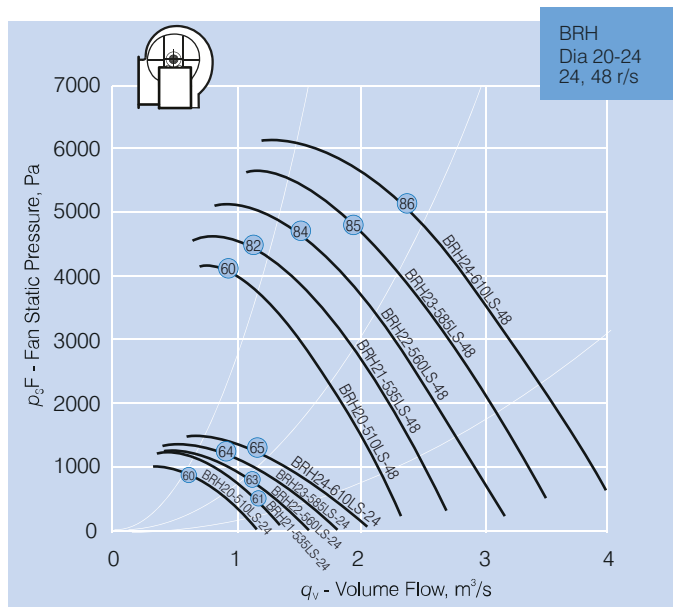
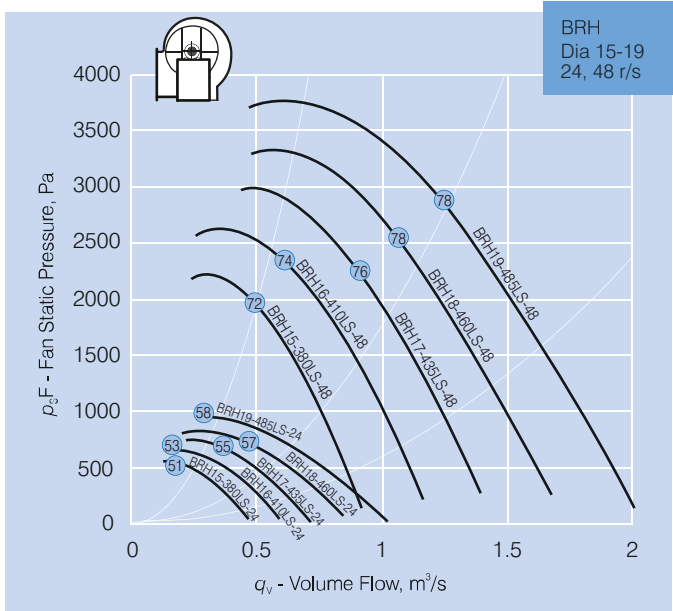
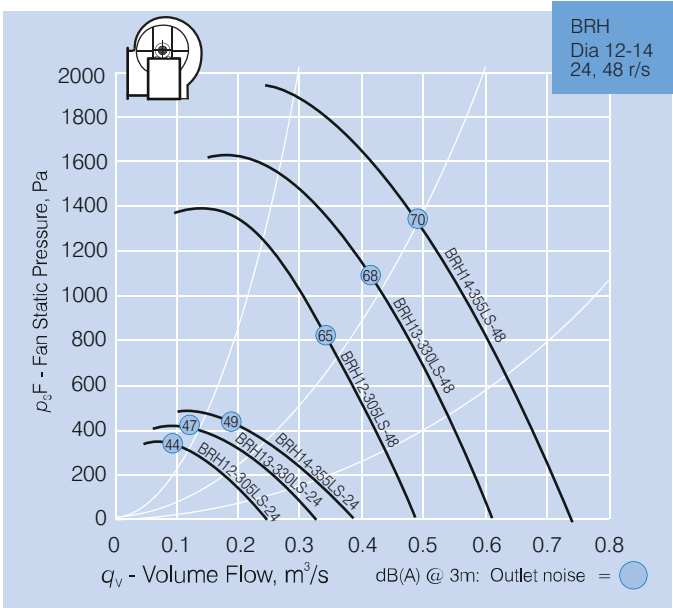

## TECHNICAL DATA - BRH HIGH PRESSURE TYPE

Model Number BRH..	Max. Speed rev/sec	Max Amps	Motor kW
12-305LS-24	24	1.63	0.55
12-305LS-48	48	1.76	0.75
13-330LS-24	24	1.63	0.55
13-330LS-48	48	2.4	1.1
14-355LS-24	24	1.63	0.55
14-355LS-48	48	3.19	1.5
15-380LS-24	24	1.63	0.55
15-380LS-48	48	4.61	2.2
16-410LS-24	24	1.63	0.55
16-410LS-48	48	5.78	3
17-435LS-24	24	1.63	0.55
17-435LS-48	48	7.56	4
18-460LS-24	24	1.63	0.55
18-460LS-48	48	10.47	5.5
19-485LS-24	24	2.1	0.75
19-485LS-48	48	14.82	7.5
20-510LS-24	24	2.68	1.1
20-510LS-48	48	14.82	7.5
21-535LS-24	24	3.44	1.5
21-535LS-48	48	20.62	11
22-560LS-24	24	3.44	1.5
22-560LS-48	48	27.77	15
23-585LS-24	24	4.7	2.2
23-585LS-48	48	27.77	15
24-610LS-24	24	6.34	3
24-610LS-48	48	34.5	18.5

\* Requires VSD - Cannot be run direct online (DOL).

# BLUE RHINO CENTRIFUGAL FANS: SWSI

## DIMENSIONS - BRH PEDESTAL HIGH PRESSURE TYPE

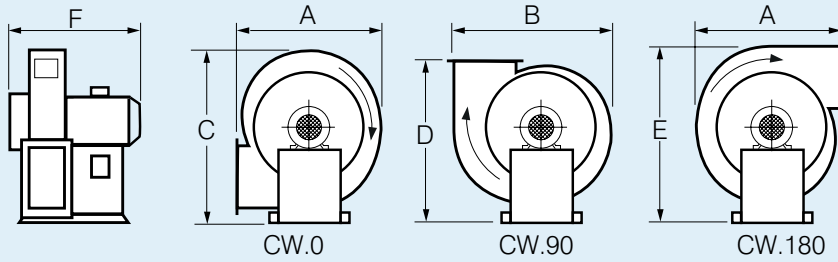

### Direction of Rotation & Discharge Position

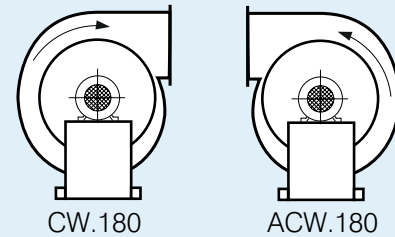
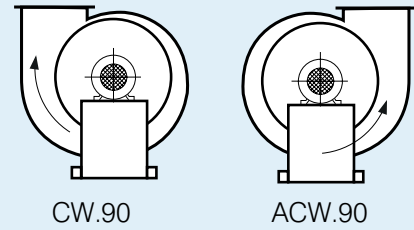
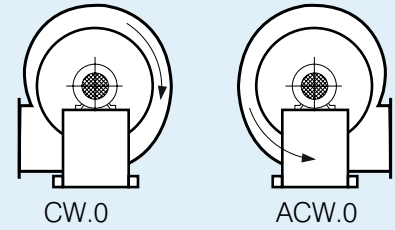

Model Number BRH..	Dimensions, mm						App. wt. kg
	A	B	C	D	E	F	
12-305LS-24	526	586	604	594	684	461	65
12-305LS-48	526	586	604	594	684	461	63
13-330LS-24	566	628	650	642	738	471	72
13-330LS-48	566	628	650	642	738	470	72
14-355LS-24	609	684	699	690	801	481	80
14-355LS-48	609	684	699	690	801	501	86
15-380LS-24	651	730	749	738	855	509	87
15-380LS-48	651	730	749	738	855	554	98
16-410LS-24	701	782	806	797	920	521	99
16-410LS-48	833	930	874	855	1000	630	123
17-435LS-24	743	828	855	844	973	531	108
17-435LS-48	743	828	855	844	973	626	146
18-460LS-24	786	874	905	893	1027	541	129
18-460LS-48	786	874	905	893	1027	668	187
19-485LS-24	833	930	960	941	1086	555	145
19-485LS-48	833	930	960	941	1086	730	211
20-510LS-24	869	972	1001	990	1145	605	162
20-510LS-48	869	972	1001	990	1145	756	222
21-535LS-24	911	1018	1050	1037	1198	636	180
21-535LS-48	911	1018	1050	1037	1198	836	289
22-560LS-24	954	1064	1100	1086	1252	648	195
22-560LS-48	954	1064	1100	1086	1252	848	313
23-585LS-24	996	1110	1150	1134	1306	684	225
23-585LS-48	996	1110	1150	1134	1306	854	330
24-610LS-24	1037	1152	1196	1183	1360	694	242
24-610LS-48	1037	1152	1196	1183	1360	913	360



Scan the QR Code to view more information online.

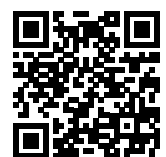

High Pressure Type