

Rapid Response

Header Box Exhaust Fan



The stylish **Rapid Response** header box exhaust fan is one of the quietest and most powerful in its class. Its aerodynamic and fully optimised design minimises resistance and produces strong, efficient air flow performance.



One of the quietest & most powerful in its class

At last, an exhaust fan that is sleek looking and does a great job of removing steam and unpleasant odours from bathrooms, ensuites and toilets. The Rapid Response ceiling mounted header box fan features a unique swing clip and removable spigot that makes it very easy to install. Every element of the Rapid Response has been optimised for peak performance and enhanced efficiency.



IPX4



Low noise



Powerful air flow



Easy to install

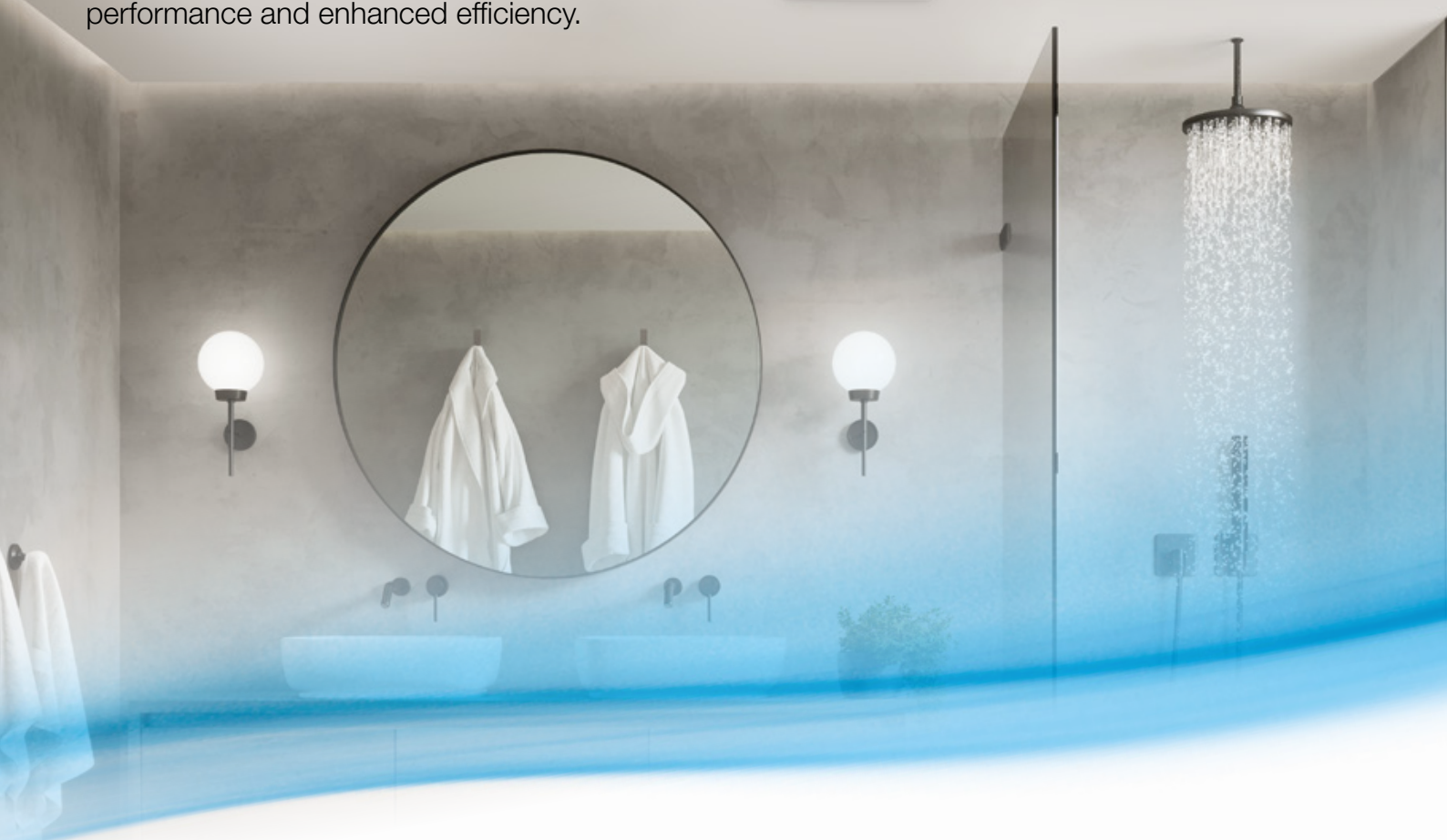

Optimised Impeller

Specially designed forward curved centrifugal impeller with an optimised variable radius inlet path. Blades are positioned at specific angles and intervals to achieve maximum air flow and efficiency, resulting in more power and less noise.

Aerodynamic Design

All parts of the fan have been aerodynamically engineered to allow air to flow through the fan with the least possible resistance, resulting in powerful performance matched with smooth and quiet operation. The inlet has been shaped to provide the smoothest entry for air and the expansion chamber is situated in the optimum position to guide air flow out of the fan.

Engineered Grilles

The matching grilles have been aerodynamically engineered to allow air to flow into the fan with minimal possible resistance, resulting in smooth efficient air flow and low noise levels.

Quiet Backdraft Shutter

Our engineering team have developed an ultra quiet backdraft shutter. It produces minimal air flow resistance and requires no power to operate.

Powerful Motor

Dynamically balanced motor with hardened steel shaft and sealed for life silicone ball bearings guarantee an extra long life span matched with high speed operation and performance.

Built To Last

We know this fan has been built correctly with only quality components. This means we can offer a 3 year warranty on our Rapid Response 250 models and a groundbreaking 5 year warranty on our Rapid Response 200 and 250HP models.



See page 6
for grille options.



216
Air Flow (m³/hr)†



200
Fan Size (mm)



Ø255
Cut Out Size (mm)

Rapid Response 200

Ducted Ceiling Fan

The ultra quiet Rapid Response 200 header box exhaust fan is ideal for odour and dampness removal from toilets, powder rooms, laundries and cupboards. It includes features such as a unique swing clip and removable spigot that makes it very easy to install.

- Advanced impeller and housing design provides powerful air flow with minimal noise.
- Can be retrofitted into an existing standard 8" round fan cut out.
- Low resistance non-return backdraft damper maximises air flow performance.
- Matching grilles are easy to remove, which makes cleaning easy.
- Includes sealed for life ball bearings.
- High strength swing clips make installation easy.
- Available with a modern square or round grille (See page 6). Square grille can be easily rotated to align with walls.
- Available with 3-15 minute adjustable run-on timer (RESPF8-T).
- Comes with spigot to suit both 100mm and 150mm duct.

Product Codes:

RESPF8 Standard fan body

RESPF8-T Fan body with run-on timer



288

Air Flow (m³/hr)[†]



250

Fan Size (mm)



Ø290

Cut Out Size (mm)



Rapid Response 250

Ducted Ceiling Fan

The Rapid Response 250 ceiling mounted header box fan features quiet operation and powerful air flow performance. It includes a fully optimised inlet cone and centrifugal impeller that maximises air pressure and ensures rooms are quickly cleared of steam and unpleasant odours. It includes a unique swing clip and removable spigot that makes it very easy to install into a standard 10" round fan cut out.

- Advanced impeller and housing design provides powerful air flow and minimises noise.
- Available with a modern square or round grille.
- Low resistance non-return backdraft damper maximises air flow performance.
- Can be retrofitted into a standard 10" round fan cut out.
- Fitted plug and lead simplifies installation.
- Includes high quality sealed for life ball bearings.



Product Codes:

RESPFG10RN Fan body with round grille

RESPFG10SQ Fan body with square grille



See page 6
for grille options.

	349 Air Flow (m ³ /hr)†
	250 Fan Size (mm)
	Ø290 Cut Out Size (mm)

Rapid Response 250HP

Ducted Ceiling Fan

The Rapid Response 250HP header box exhaust fan is one of the quietest and most powerful in its class. Its aerodynamic and fully optimised design minimises air flow resistance and produces powerful, efficient performance.

- Rapid Response 250HP provides strong air flow performance to ensure steam is cleared from rooms such as bathrooms and ensuites.
- It includes features such as a unique swing clip and removable spigot that makes it very easy to install.
- Advanced impeller and housing design provides powerful air flow and minimises noise.
- Can be retrofitted into an existing standard 10" round fan cut out.

- Low resistance non-return backdraft damper maximises air flow performance.
- Matching grilles are easy to remove, which makes cleaning easy.
- Includes high quality sealed for life ball bearings.
- High strength swing clips make installation easy.
- Modern square or round grilles available (See page 6). Square grilles can be easily rotated to align with walls.
- Available with 3-15 minute adjustable run-on timer (RESPF150T).

Product Codes:

RESPF150 Standard fan body

RESPF150T Fan body with run-on timer

Rapid Response Standard Grilles

The stylish and modern Rapid Response grille is available in round and square designs with white or black finish.

- Innovative design allows grilles to be easily removed for cleaning.
- Available in 2 sizes to suit 8" and 10" Rapid Response header box fan.
- Quick and easy to install to fan body.
- Can be retrofitted to a previously installed Rapid Response fan.

See back page for product codes and dimensions



Round grille white finish



Square grille white finish



Round grille black finish



Square grille black finish

Rapid Response Grilles with LED Light

The Rapid Response grille with LED light will brighten up any bathroom, ensuite, powder room or toilet. They are quick and easy to install, and feature a stylish, modern design to suit any setting. For added convenience the LED light can be controlled separately to the fan.

- Available in round and square designs with white or black finish.
- Available in 2 sizes to suit 8" and 10" Rapid Response fan.
- 8" LED model is ideal for toilets and powder rooms, as it includes a light.
- Can be retrofitted to a previously installed Rapid Response fan.
- Grilles can be easily removed for cleaning.
- Complies to: AS/NZS 60598.2.2:2001 and AS/NZS 60598.1:2013 Certificate No.: SAA152082.
- Three colour temperature options to match other installed lights.

See back page for product codes, dimensions & specifications.



Round grille white finish with 3 colour temperature LED light



Square grille white finish with 3 colour temperature LED light



Round grille black finish with 3 colour temperature LED light



Square grille black finish with 3 colour temperature LED light

Tri-Switch LED

Grilles come factory pre-set to cool white (4200K), but can be changed to warm white (3000K) or daylight (6000K) by changing the position of Tri-Switch located on back of grille.



Warm White Cool Daylight White



Warm White



Cool White

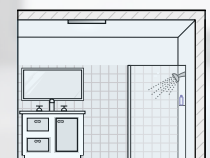

Daylight

(Colour Temperature: 3000K) (Colour Temperature: 4200K) (Colour Temperature: 6000K)

Colour indicated in drawings above is for illustrative purposes only.

Grille to Duct Connector

The easy to install Rapid Response grille to duct connector is designed to fit one of our stylish and modern 8" Rapid Response grilles and flexible duct. The grille to duct connector is suited for ducted systems using an in-line, roof, or external wall mounted fan. Grilles are quick to remove, making them easy to clean.

- High strength swing clips make installation easy.
- Can be retrofitted into a standard 8" (255mm) round cut out.
- Designed to fit our range of 8" Rapid Response grilles.
- Suitable for 150mm ducting.

Product Code: RESP8-DCON

Dimensions

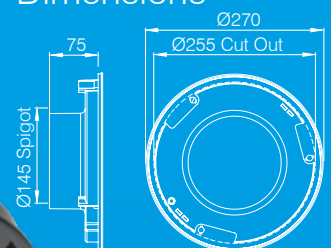











All dimensions in mm

Rapid Response Selection Guide



















Select suitable fan body size

Step 1

Application	 Toilets  Powder rooms	 Small/medium bathrooms  Small/medium ensuites	 Medium/large bathrooms  Medium/large ensuites
	 Walk in wardrobes  Laundries	 Rapid Response 250	
Model	 Rapid Response 200		

Step 2

Select grille type

To suit 8" fan body (RESPF8/-T)		10" fan and grille combination		To suit 10" fan body (RESPF150/T)	
	Square grille white finish (RESPG8-SQWH)		10" fan and square grille white finish (RESPFG10SQWH)		Square grille white finish (RESPG150SQWH)
	Square grille white finish with Tri-Switch LED light (RESPG8-SQWH-TRILED)		10" fan and round grille white finish (RESPFG10RNWH)		Square grille white finish with Tri-Switch LED light (RESPG150SQWH-TRILED)
	Square grille black finish (RESPG8-SQBK)				Square grille black finish (RESPG150SQBK)
	Square grille black finish with Tri-Switch LED light (RESPG8-SQBK-TRILED)				Square grille white finish with Tri-Switch LED light (RESPG150SQBK-TRILED)
	Round grille white finish (RESPG8-RNWH)				Round grille white finish (RESPG150RNWH)
	Round grille white finish with Tri-Switch LED light (RESPG8-RNWH-TRILED)				Round grille white finish with Tri-Switch LED light (RESPG150RNWH-TRILED)
	Round grille black finish (RESPG8-RNBK)				Round grille black finish (RESPG150RNBK)
	Round grille black finish with Tri-Switch LED light (RESPG8-RNBK-TRILED)				Round grille white finish with Tri-Switch LED light (RESPG150RNBK-TRILED)

Installation Made Easy



Long clip-in spigot makes installation and duct connection easier.

**RAPID
RESPONSE**
HEADER BOX EXHAUST FAN



Rotate swing clips to hold fan body in place.



Tighten screws so clips clamp onto ceiling board.

Dimensional Data

Model Number	Description	Dimensions, mm											
		Cut Out AØ	B	C 100/150mm spigot	D								
Fan Body													
RESPF8	8" Ducted ceiling fan	255	195	105/170	94/120								
RESPF8-T	8" Ducted ceiling fan with run-on timer												
RESPF150	10" Ducted ceiling fan	290	197	170	120								
RESPF150T	10" Ducted ceiling fan with run-on timer												
Model Number	Description	Dimensions, mm											
		Cut Out AØ	B	C	D	E	FØ	Cut Out GØ	H	I	J	K	L
Fan Body with Grille													
RESPFG10RN	10" Ducted ceiling fan with round grille	290	197	170	120	24	332	-	-	-	-	-	
RESPFG10SQ	10" Ducted ceiling fan with square grille	-	-	-	-	-	-	290	197	170	120	30	353
Model Number	Description	Dimensions, mm											
		A	B	C	D								
Grilles													
RESPG8-SQWH	8" Square Grille White Finish	300	28	-	-								
RESPG8-SQWH-TRILED	8" Square Grille White Finish with LED Light	300	28	-	-								
RESPG8-SQBK	8" Square Grille Black Finish	300	28	-	-								
RESPG8-SQBK-TRILED	8" Square Grille Black Finish with LED Light	300	28	-	-								
RESPG8-RNWH	8" Round Grille White Finish	-	-	294	19								
RESPG8-RNWH-TRILED	8" Round Grille White Finish with LED Light	-	-	294	19								
RESPG8-RNBK	8" Round Grille Black Finish	-	-	294	19								
RESPG8-RNBK-TRILED	8" Round Grille Black Finish with LED Light	-	-	294	19								
RESPG150SQWH	10" Square Grille White Finish	353	30	-	-								
RESPG150SQWH-TRILED	10" Square Grille White Finish with LED Light	353	30	-	-								
RESPG150SQBK	10" Square Grille Black Finish	353	30	-	-								
RESPG150SQBK-TRILED	10" Square Grille Black Finish with LED Light	353	30	-	-								
RESPG150RNWH	10" Round Grille White Finish	-	-	332	24								
RESPG150RNWH-TRILED	10" Round Grille White Finish with LED Light	-	-	332	24								
RESPG150RNBK	10" Round Grille Black Finish	-	-	332	24								
RESPG150RNBK-TRILED	10" Round Grille Black Finish with LED Light	-	-	332	24								

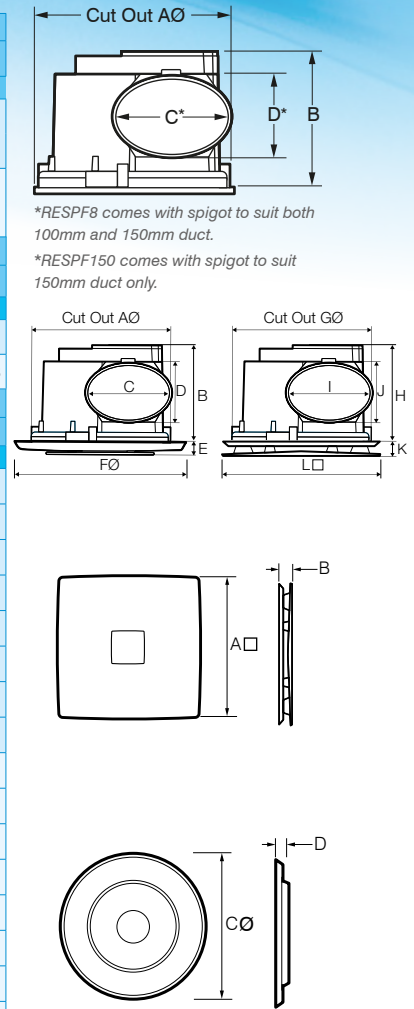

Technical Data

Model Number	Run-on Timer	Air flow ¹		Fan Speed RPM	Average Sound Level dB(A) @ 3m	Watts	Volts
		m ³ /hr ¹	L/sec ¹				
Fans							
RESPF8	No	216	60	950	29	30	230-240
RESPF8-T	Yes						
RESPF150	No	349	97	950	37	60	230-240
RESPF150T	Yes						
RESPFG10RN	No	288	80	950	38	40	230-240
RESPFG10SQ	No						

¹Air flow without duct and fittings

Model Number	Description	Lumens (LM)	Input Power (W)	Colour Temp (K)	Beam Angle (°)
RESPG8-SQWH-TRILED	8" Square Grille White Finish with LED Light	1000	12	3000/4200/6000	180
RESPG8-SQBK-TRILED	8" Square Grille Black Finish with LED Light	1000	12	3000/4200/6000	180
RESPG8-RNWH-TRILED	8" Round Grille White Finish with LED Light	800	9	3000/4200/6000	180
RESPG8-RNBK-TRILED	8" Round Grille Black Finish with LED Light	800	9	3000/4200/6000	180
RESPG150SQWH-TRILED	10" Square Grille White Finish with LED Light	1000	12	3000/4200/6000	180
RESPG150SQBK-TRILED	10" Square Grille Black Finish with LED Light	1000	12	3000/4200/6000	180
RESPG150RNWH-TRILED	10" Round Grille White Finish with LED Light	800	9	3000/4200/6000	180
RESPG150RNBK-TRILED	10" Round Grille Black Finish with LED Light	800	9	3000/4200/6000	180



Scan the QR Code for more information



Fantech Pty. Ltd.

Victoria: (+61 3) 9554 7845
 New South Wales: (02) 8811 0400
 South Australia: (08) 8294 0530
 Northern Territory: (08) 8947 0447
 Queensland: (07) 3299 9888
 Western Australia: (08) 9209 4999
 A.C.T.: (02) 6280 5511
 New Zealand: (09) 444 6266

www.fantech.com.au | [Twitter](#) | [LinkedIn](#) | [Facebook](#) | [YouTube](#)

For sales enquiries contact:

Specifications and design subject to change without notice.