

JETVENT

Integrated Car Park Ventilation Solutions

A Practical Guide for Selection & Application: Edition 4.0



Fantech's **JetVent Car Park Ventilation System** provides an innovative solution that uses demand control ventilation to help ensure a high standard of air quality whilst minimising energy consumption. It utilises the Fantech's Aviator controls to digitally connect JetVent fans, Supply & Exhaust fans, Sensors and the Building Management System (BMS) together. This connectivity reduces installation time, capital cost, creates a higher level of system monitoring, seamless control and fast commissioning.



Introduction to JetVent Car Park Ventilation Solutions

The ventilation of car parks is essential for removing vehicle exhaust fumes containing harmful pollutants. Some of these pollutants include Carbon Monoxide (CO), Nitrogen Dioxides (NO₂), Sulphur Dioxide (SO₂) and heavy metal compounds.

The JetVent ventilation system is based on a number of small high velocity JetVent fans that replaces traditional distribution ductwork in closed car parks or increases cross-flow ventilation in open car parks. This system is an alternative option for mechanical ventilation. Fantech's JetVent Car Park ventilation solution is designed so it can match any car park design and uses smart demand control ventilation to ensure a high standard of air quality. It can be used in place of both traditional ducted and non-ducted car park systems.





Introduction to JetVent Car Park Ventilation Solutions	2-7
JetVent Fan Types	
High Performance JetVent Fans	8
Standard Height JetVent Fans	9
Low Height JetVent Fans	10
JetVent Technical Data	11
JetVent Ancillaries	
Smoke Detection	12
Axial Flow Fans and Attenuators	13
Control Systems	
Aviator MAX Control System	14-15
Aviator MINI Control System	16-17
System Layouts & Applications	
Assisted Natural Flow/Augmented Ducted System	18
Linear Flow	19
Circular Mixing	20
Designing & Implementing the System	
Step 1 – Assess Car Park Geometry	
(a) Natural air path	21
(b) Ceiling features	22
(c) Vertical clearance	22
(d) Obstructions	22
(e) Clashes with other services	23
Step 2 – Identify Fan Selection and Spacing	24
Step 3 – Design Example	26-27
Step 4 – Calculate Supply and Exhaust Rates	28
Step 5 – Select the Aviator Control System	29
Step 6 – Installation	30
Step 7 – Commissioning the System	30
Step 8 – Maintenance	31
System Compliance	32-35
Computational Fluid Dynamics (CFD) Analysis	36-37
References	38
Appendix	38-39

How it works

JetVent Fans operate on well proven longitudinal tunnel ventilation principles. The fans produce a high velocity jet of air, in turn moving a larger quantity of air surrounding the fan through a process known as entrainment. The amount of air entrained by a single fan increases with the velocity and the quantity of air being discharged by the fan. These characteristics directly relate to the thrust rating of the fan, which is measured in Newtons (N).

Figures 1(a) and 1(b) show the difference in principle between Ducted and JetVent ventilation systems.

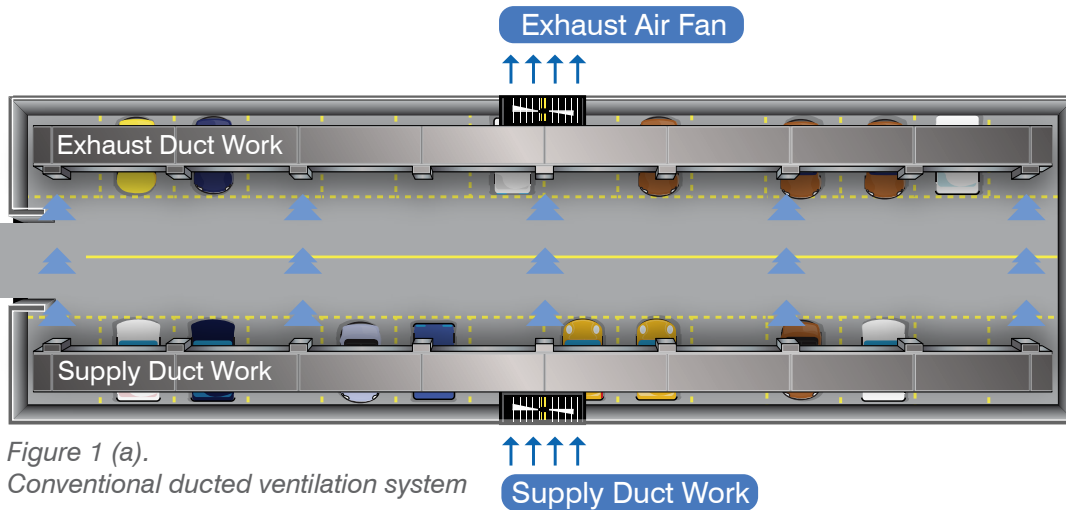

Figure 1 (a).
Conventional ducted ventilation system

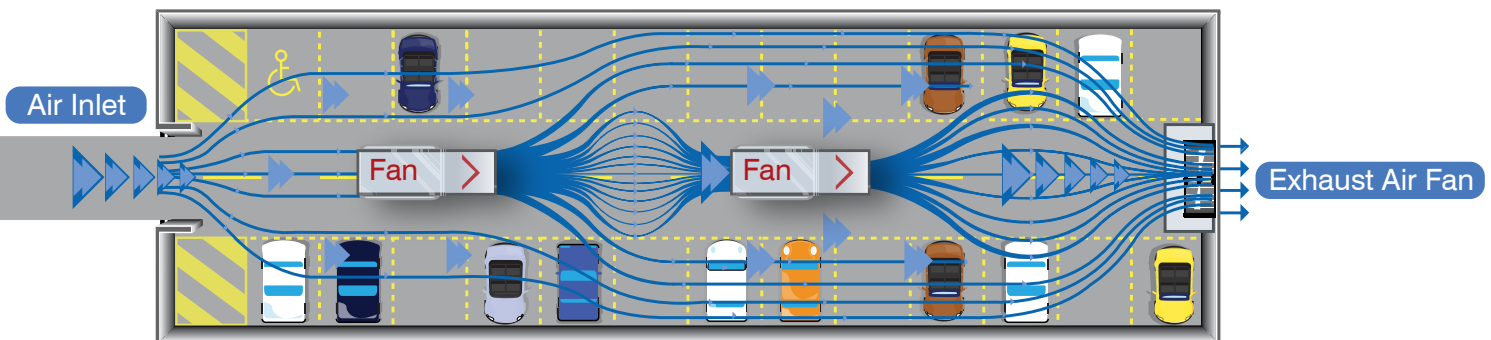

Figure 1 (b).
JetVent ventilation system

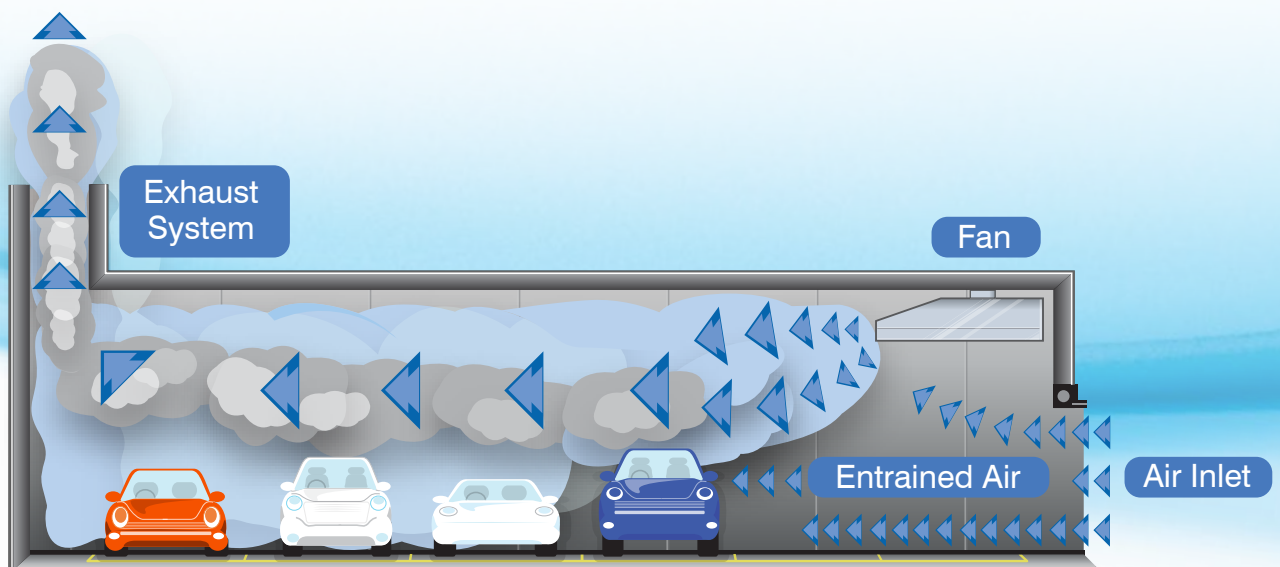

Figure 2. Workings of a JetVent fan



Fan Specifications

The capacity of a single fan increases with its thrust rating. All JetVent car park fans are rated according to this in Newtons (N) of thrust. See page 24 for further information.

All JetVent Fan types are tested to the following Standards:

- Thrust performance based on tests to BS848: Part 10:1999.
- Noise data based on tests to BS848: Part 2:1985.

Advantages

- Largely eliminates the need for air distribution ductwork within the car park.
- The mechanical supply and exhaust systems have less resistance and therefore require smaller fans that consume less power.



- Ventilation risers and plant rooms reduce in size and quantity, making the car park more open and possibly yielding additional car park spaces.



- Increased number of control zones in car parks for targeted ventilation. This can increase the energy efficiency of the system over and above the best ducted car park ventilation systems.



- Great potential for reduced excavation and construction costs. System is small in vertical profile and the placement of fans can be very flexible resulting in lower floor-to-ceiling heights.



Intelligent JetVent Fans

Fantech offers a range of JetVent fans that feature advanced digital EC motor technology with integrated speed control. It allows precise control of every JetVent and the ability to implement a system that connects sensors directly to the fans.

The revolutionary feature of this system is ComLink, the digital communication between JetVent fans, sensors and the pre-configured Fantech Aviator Controller. The result is a very simple control wiring scheme that is easy to install and commission, while providing a high level of energy efficiency and system monitoring. The Aviator controller will vary the operating speed of the fans and therefore the ventilation rate, according to the CO or NO₂ pollutant levels in the car park.

The JetVent fan speed is pre-set so it does not operate above the recommended noise level of 65dB(A) @ 8m (AS2107:2000).

Pollutant Monitoring

The innovative Aviator controller monitors pollutant sensors connected to the system and adjusts the JetVent fan's operating speed to meet the air quality requirements. Both Carbon Monoxide (CO) and Nitrogen Dioxide (NO₂) sensors can be connected to the nearest main Aviator controller, Expansion Module, JetVent fan or Danfoss VLT Drive. These sensors are typically 4-20mA type or 0-10Vdc type and can be Modbus enabled.

Temperature Monitoring

The Aviator controller can also monitor temperature sensors connected to the system. If a hot area is identified within the car park such as near an air conditioning condenser, JetVents fans turn on when demand ventilation is required to reduce the temperature. These sensors are typically the 4-20mA or 0-10Vdc type and can be Modbus.

Smoke Detection

The Aviator control system can be activated to monitor Fantech smoke detection sensors. Duct probe smoke detectors can be fitted to the side of each JetVent fan and additional decentralised smoke detection sensors can be connected to the JetVent fans or Aviator controller as required. The Aviator controller can also be integrated into a third party smoke detection system if required. Refer to page 12 for further information.

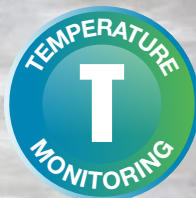

High Performance (HP) JetVent Fans

The JetVent HP is designed for car park applications that require high ventilation rates and where varying levels of pollutants need to be removed quickly and efficiently. These high performance EC fans have a thrust rating of 91.8 newtons at high speed and pre-set setting of 48.2 newtons making them well suited to car parks with high ceilings and high load requirements.

High performance (HP) JetVents have a 50 metres recommended fan spacing due to their high thrust rating and an average of 1000m² coverage per unit used.



Standard Height (SD & USD)

JetVent Fans

Standard height JetVents are designed for typical car park layouts and ceiling heights. They use the same advanced digital EC motor technology, have a high speed thrust rating of up to 52 Newtons and a pre-set speed thrust rating of up to 38.5 Newtons.

The Standard height JetVent fan is available with two impeller variations. The centrifugal aluminium type impeller is designed to produce a high volume air flow (at high speed). The second model features a cutting edge mixed flow impeller that is designed to be quieter and ultra energy efficient.

*Centrifugal aluminium
impeller type (SD)*

*Mixed flow
Ultra impeller type (USD)*



Low Height (LH & ULH)

JetVent Fans

The EC series of Low Profile JetVent fans are designed to clear harmful pollutants from enclosed and semi-enclosed spaces. They feature a compact overall size and a very narrow height, which may enable the car park's floor to ceiling dimensions to be reduced.

The Low Profile series comes in two different sizes and impeller variation. The 3-phase model with a centrifugal aluminium impeller has been developed for higher air flows and has a pre-set speed thrust rating of 23 Newtons. The Low Profile JetVent also comes as much more compact, single phase unit with mixed flow 'Ultra' impeller, has been designed to be quieter and has a pre-set speed thrust rating of 18.9 Newtons.



Ultra Low Height (ULH) model



Low Height (LH) model



JetVent Technical Data

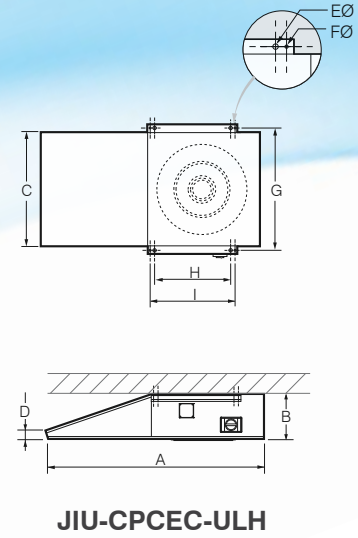
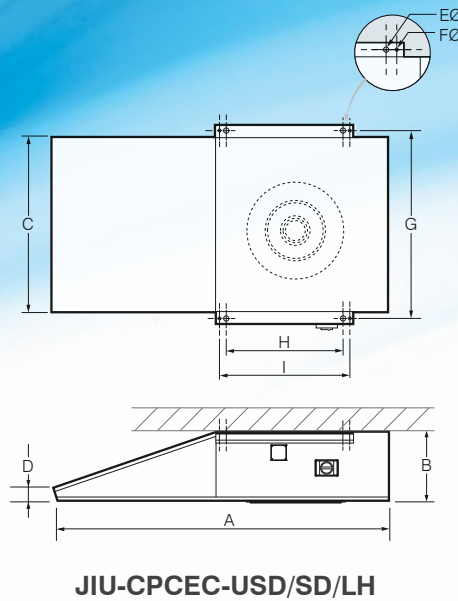
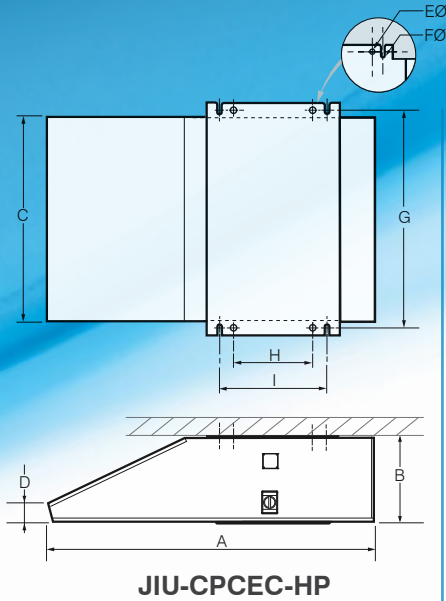

Product Code	A	Vertical Height B	C	D	E	F	G	H	I	Approx. Weight kg
JIU-CPCEC-HP	1833	492	1151	110	30	16	1240	450	600	160
JIU-CPCEC-USD	1745	370	906	68	25	13	973	605	675	89
JIU-CPCEC-SD	1745	370	906	68	25	13	973	605	675	89
JIU-CPCEC-LH	1745	322	906	68	25	13	973	605	675	89
JIU-CPCEC-ULH	1040	262	488	55	20	12	537	350	410	26

Dimensions in mm

Product Code	Fan Speed		Thrust Rating		Car park Installed Noise Levels		Free-field Noise Rating		Power Consumption		Current		Input Power	
	rpm		N		dB(A) @ 8m [#]		dB(A) @ 3m ^{**}		kW		A			
	High speed	Pre-set speed*	High speed	Pre-set speed*	High speed	Pre-set speed*	High speed	Pre-set speed*	High speed	Pre-set speed*	High speed	Pre-set speed*		
JetVent EC	JIU-CPCEC-HP	1230	858	91.8	48.2	75.2	65.0	65.8	56.5	2.9	1.0 [~]	4.8	1.6	415V
	JIU-CPCEC-SD	1770	1296	52.2	28.4	72.4	65.0	64.4	56.7	1.7	0.7 [~]	2.9	1.1	415V
	JIU-CPCEC-LH	1770	1120	46.8	18.9	76.4	65.0	68.7	56.7	1.7	0.4 [~]	2.9	0.8	415V
JetVent EC Ultra	JIU-CPCEC-USD	1450	1400	38.9	36.5	66.5	65.0	58.3	56.7	1.1	1.1	1.8	1.8	415V
	JIU-CPCEC-ULH	2100	2100	23.0	23.0	64.8	64.8	56.8	56.8	0.56	0.56	2.8	2.8	240V

[#] Car park installed noise levels apply 8m away from the fan with multiple fans operating.

^{**} Free-field noise rating applies 3m away from the fan with multiple fans operating.

Contact your nearest Fantech office to confirm if this is applicable to your installation.

[~] Estimated power consumption.

* Pre-set speed so fan does not operate above the AS2107:2000 recommended noise level of 65dB(A) @ 8m.

Smoke Detection

Fantech's Aviator control system comes with optional integrated smoke detection. Smoke detectors can be fitted as duct probes to the side of each JetVent fan or installed as optional decentralised detectors that link to the JetVent fans, or controller via ComLink (RS485). Once the smoke detectors are installed, the Aviator controller will switch to smoke detection mode and continuously monitor the level of smoke in a car park.

Aviator smoke detection operates as an early warning system should the event of a fire occur in the car park. The controller will display an alert on its graphic interface, activate warning alarms and flag the BMS if connected. The JetVent fans will turn off (0%) and the supply and exhaust fans will operate at full speed (100%) in compliance with AS1668.1. It can also be configured to suit local regulations or building designs if required. The Aviator controller will continue to monitor the activated smoke detector, and if cleared it will reset and return to normal car park ventilation mode.

Note (A): Aviator smoke detection must NOT be connected to the Fire Detection Control Indication Equipment (FDCIE). This is an early detection and shutdown system to ensure the JetVent fans do not impact the operation of the installed fire detection and suppression system, and minimise the smoke conditions in the car park.

Note (B): If a third party smoke detection system is used, the Aviator controller can be connected via its smoke detection input.

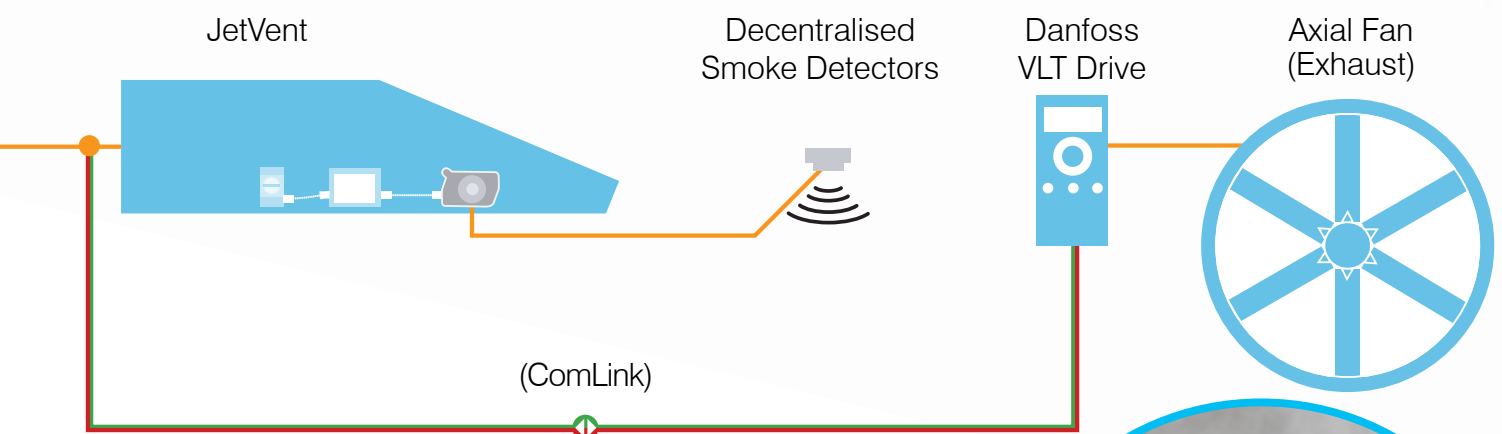

Smoke detectors can be factory fitted to the JetVent fans and installed throughout the car park with a direct network connection to the JetVent. All smoke detectors are continuously monitored by the Aviator controller using Modbus RTU system communications and powered via the jet fan.

*Pictured:
Danfoss VLT drive*



Axial Flow Fans and Attenuators

Pictured: APV Axial flow exhaust fan with C1 series attenuator

Fantech's axial flow fans are available in an extensive range of sizes and variants to suit both supply or exhaust applications in car parks. They can be manufactured as vertical mount for riser installations and horizontal mount, typically used in plant rooms.

They are available in 13 sizes extending from 315 to 2000mm diameter and can be fitted with matching rectangular or circular attenuators.

- Casings are made of durable galvanised steel
- Casings of stainless steel, other materials or special coatings can be supplied
- Axial flow fans can be made with a specific impeller pitch angle to accurately meet the specification
- Matching attenuators can be supplied to achieve superior noise reductions in car park applications



Pictured: AP Axial flow supply fan with C2 series attenuator



Aviator MAX

Ideal for Large Commercial Car Park Applications

The Aviator MAX Controller is a tailored solution to efficiently manage large commercial car park ventilation applications. It has been developed to increase the energy efficiency of a car park, while ensuring the ventilation output is optimised. Aviator MAX works in conjunction with JetVent fans, pollutant sensors, VSDs, supply/exhaust fans and the Building Management System.

- AS1668.2 compliant atmospheric contaminant monitoring system
- Connect up to 50 JetVent fans, 16 Danfoss VLT Drives, 50 Fieldbus Sensors and 5 expansion modules
- Connect to either the 4.3" or large 7" graphic user interface (GUI)
- Can be connected to a BMS for easy system monitoring; Modbus or BACnet
- Three Mechanical switch board connections for Supply/Mixer/Exhaust fan groups with On/Auto/Off modes of operation
- Six Demand zones and one Fire Zone operation
- Integrated Smoke detection system for quick shut down
- Purge timer with real time clock and run indicator alarm
- Includes up to 20 program schedules



Aviator 7" GUI

Large Screen for Easy Navigation

The Aviator 7" touchscreen features an intuitive and easy-to-use Graphic User Interface that works with the Aviator Max and Mini controllers. It can be mounted up to 500m from the Max or Mini controller, either on a mechanical service panel or within the control room.

- One 7" GUI can monitor up to 12 Aviator controllers separately
- Main screen summarises the system status and includes highest pollutant sensor monitoring
- Zone screens for each demand control area
- Individual screens for every fan and sensor that is connected
- Service setting and controller remote access screens
- Mechanical Services Auto/On/Off touchscreen control



Aviator MAX Control System Layout



Connects to Fire Panel (FDCIE)
For General Fire Alarm and JetVent On/Auto/Off requirements



Connects to Mechanical Services Switchboard (MSSB)
Inputs for On/Auto/Off of JetVent, supply and exhaust fan groups



Connects to on-board general control

- Alarm indication
- Sensors
- Relays
- Two speed relays
- Run indication
- 0-10Vdc signals



Connects to each fan or Variable Speed Drive

- Up to 2 CO, NO₂ or temperature sensors
- Up to 2 Smoke Detection Points



Controls up to 50 JetVent fans

- Digital EC JIU-CPCEC Series
- With isolator or smoke detector



Connects up to 16 Danfoss VLT Variable Speed Drives

- Supply, mixer & exhaust modes



Connects to a maximum of 50 ComLink sensors (Field Bus)

- CO
- NO₂
- Temperature



Connects to BMS

- BACnet/IP
- BACnet MS/TP



Connects to Integrated Web Server

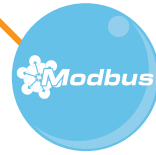

Connects to BMS

- Modbus TCP
- Modbus RTU



Connects to the Aviator GUI
With integrated temperature and humidity sensors

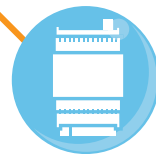

Add up to 5 expansion modules via RS485

- Alarms & relays
- Sensors
- Run indication
- 0-10Vdc signals
- Advanced features
- Two speed relays

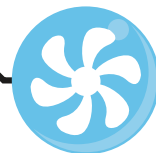

Connects to Fantech supply and exhaust fans
An extensive range of sizes and types available

Aviator MINI

Ideal for Smaller Enclosed Car Parks

The Aviator MINI Controller is designed to efficiently manage smaller car park ventilation applications that have only one mechanical switchboard with Auto/On/off control for all fans. It has been developed to increase the energy efficiency of a car park, while ensuring the ventilation output is optimised. Aviator MINI works in conjunction with JetVent fans, pollutant sensors, VSDs, supply/exhaust fans and Building Management Systems. The MINI controller can be configured to match your car park's individual requirements.

- AS1668.2 compliant atmospheric contaminant monitoring system
- Connect up to 50 JetVent fans, 16 Danfoss VLT Drives and 20 Fieldbus Sensors
- Connect to either the 4.3" or large 7" graphic user interface (GUI)
- Can be connected to a BMS for easy system monitoring; Modbus or BACnet
- One mechanical switch board connections for Supply/Mixer/Exhaust fan groups with On/Auto/Off modes of operation
- Six Demand zone and one Fire Zone operation
- Integrated Smoke detection system for quick shut down
- Purge timer with real time clock and run indicator alarm
- Includes up to 20 program schedules



Aviator 4.3" GUI

Easy to Use and Navigate

The Aviator 4.3" touchscreen has been designed to be an easy-to-use Graphic User Interface for the Aviator Max and Mini controllers. Similar to the larger 7" touchscreen model, this Aviator 4.3" GUI can be mounted up to 500m away from the main controller.

- One 4.3" GUI can monitor one Aviator controller
- Main screen summarises the system status and includes highest pollutant sensor monitoring
- Zone screens for each demand control area
- Individual screens for every fan and sensor that is connected
- Service setting & controller remote access screens
- Mechanical Services Auto/On/Off touchscreen control



Aviator MINI Control System Layout

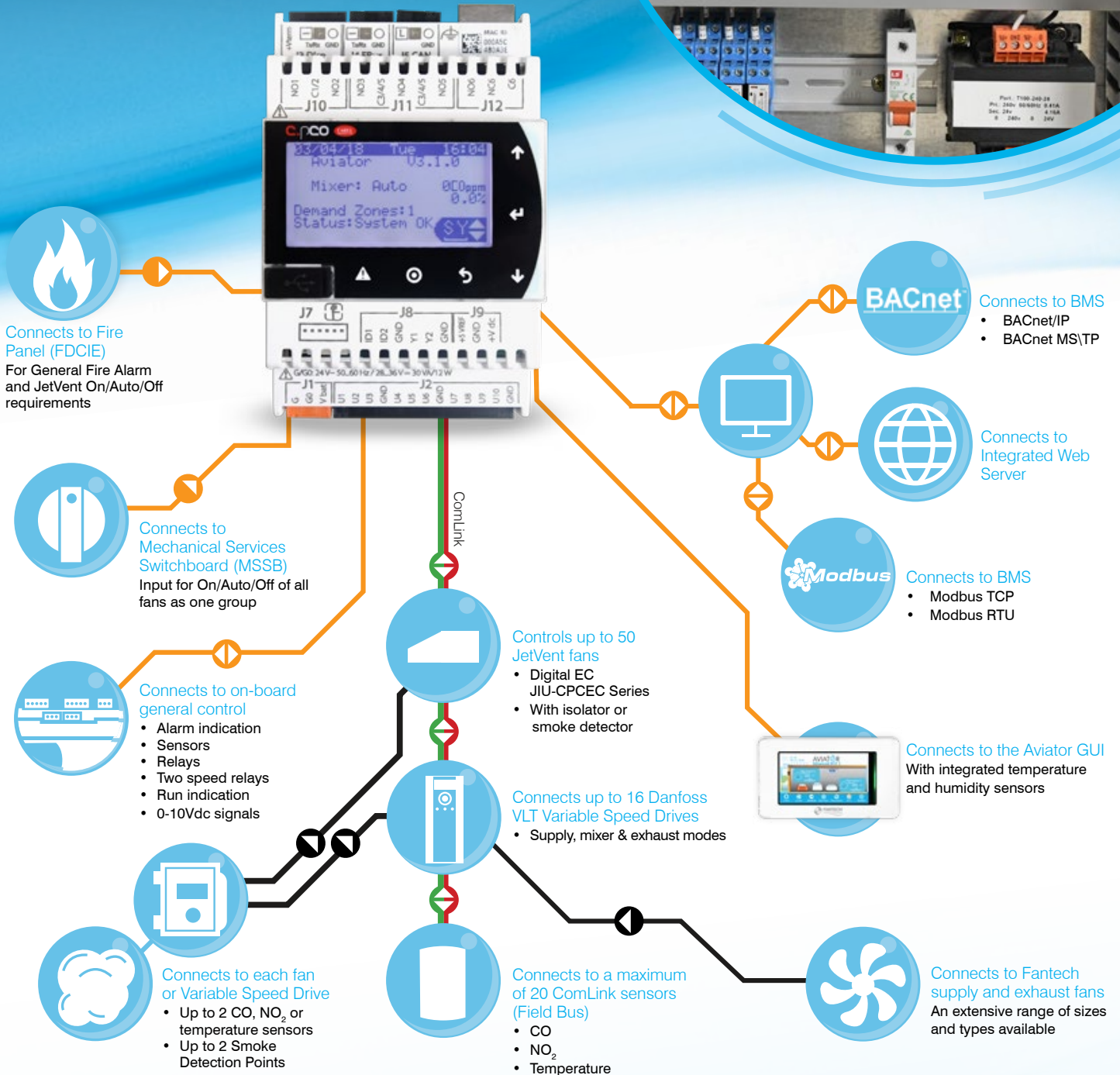

System Layouts & Applications

Assisted Natural Flow/Augmented Ducted System

Where supply and exhaust air outlets are a large distance apart (more than 40m), there must be provisions to ensure air moves evenly across the width of the car park.

JetVent Fans can be used to maintain constant air movement in these car parks to remove the effects of air stagnation and the resulting build up of pollutants. In large open car parks, JetVent Fans can be used to create a large pressure difference between supply and exhaust, hence boosting air flow in and out of the car park as shown below.

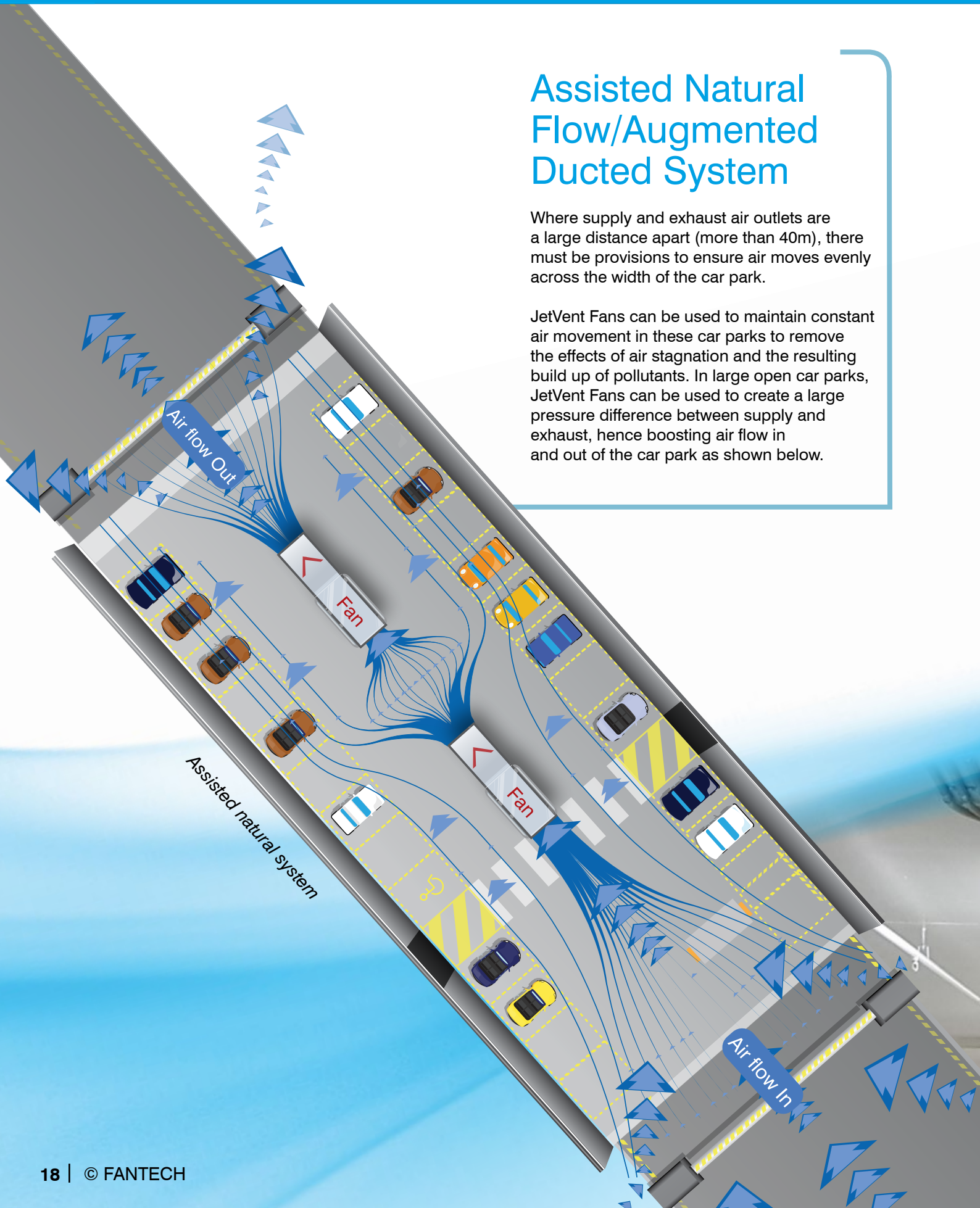



Linear flow

A linear flow system uses JetVent Fans pointing in the same general direction to move air from one end of a car park to the other. This system is similar to a traditional mechanically ducted system. The main difference is that the JetVent Fans direct air flow from a single supply point to a single exhaust point.

For this scheme to work effectively, the exhaust and supply points should be located on opposing ends of the car park across its longest dimensions. If this is not the case, units arranged for circular mixing may be a better solution.

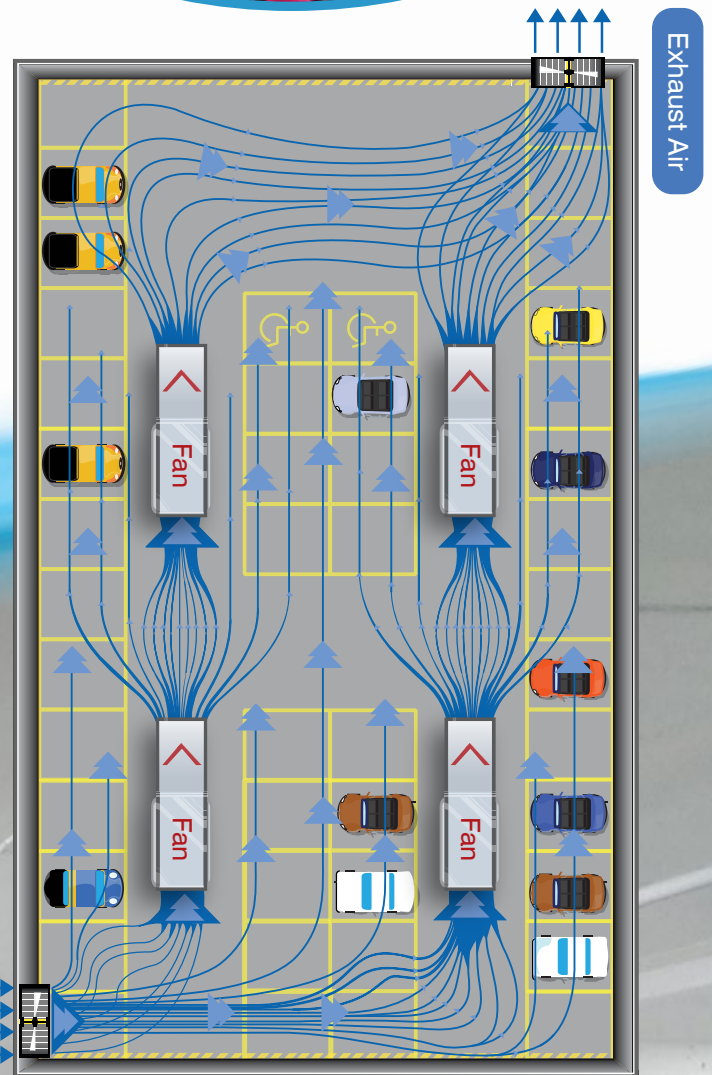

Linear flow system

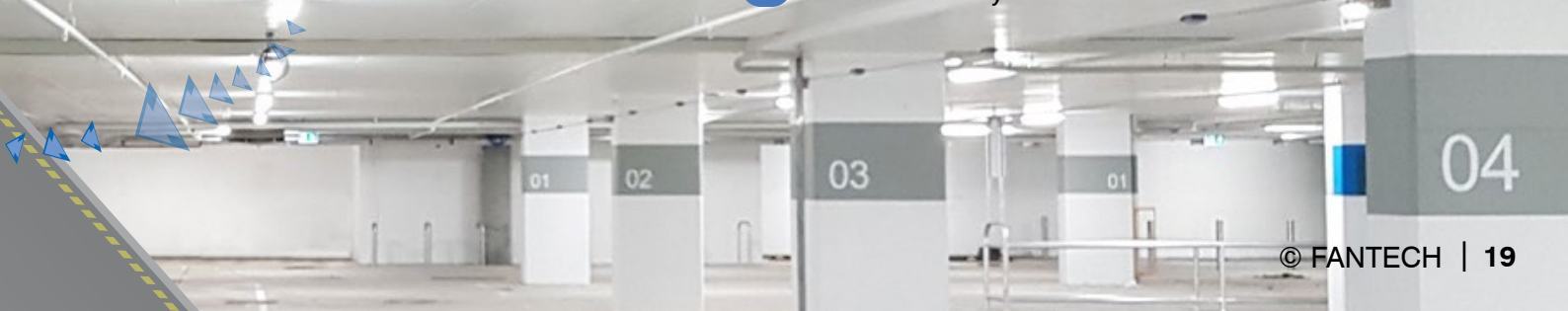



Circular mixing

JetVent Fans can be positioned around the car park to generate air movement in a circular pattern. The result is that air gets mixed and stirred throughout the entire area, which provides greater dilution of pollutants within the car park. This system layout example shows the direction of air flow from supply to exhaust.

Circular mixing is suitable for smaller car parks. This system also provides added flexibility when positioning supply and exhaust points. Unlike a linear flow system, a circular mixing system does not require exhaust and supply points to be on opposite sides of the car park.

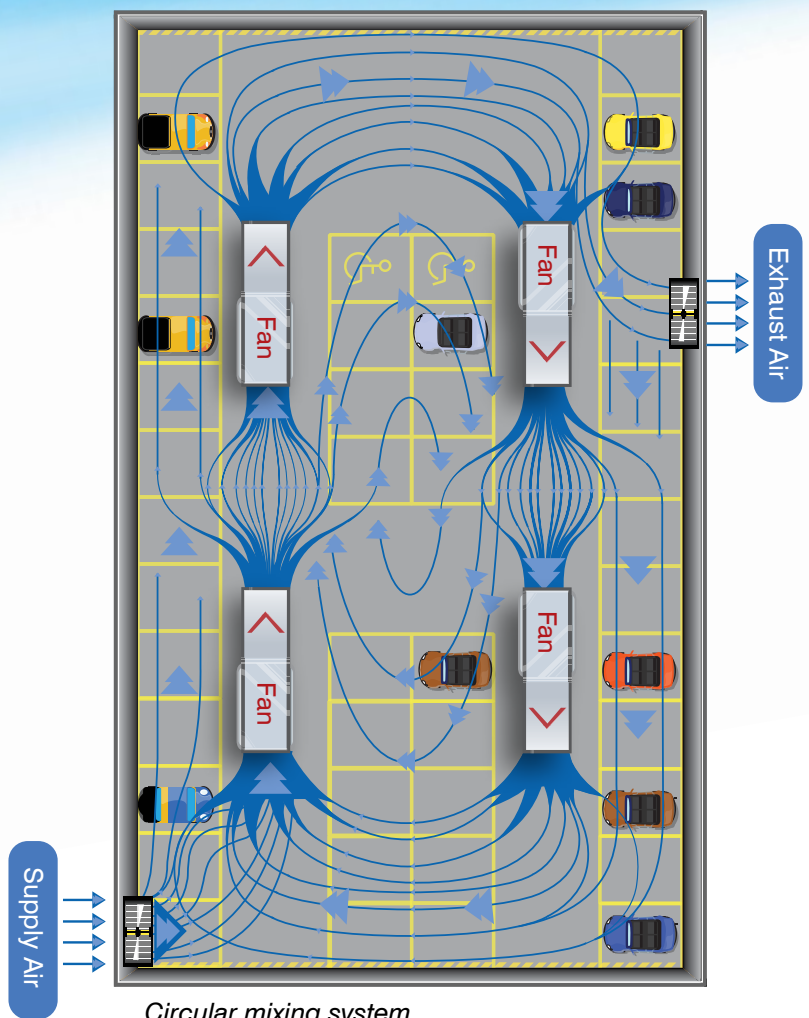

Circular mixing system

Designing & Implementing the System

Estimating fan quantities

For the purpose of estimating costs, the steps on the following pages may be bypassed. Allow 5N of thrust per 100m² of car park floor area to approximate the number of fans required.

The following steps are sufficient to create an initial ventilation system design.

A Computational Fluid Dynamics (CFD) analysis is often required to prove and further refine the design. Fans may need to be re-orientated, or in some cases, added or removed.

A ventilation system can be tailored to suit virtually any car park. Before considering fan locations, the system layout will need to be identified. Refer to the previous section for information relating to system layouts and their suitability for particular car parks.

Step 1 Assessing Car Park Geometry

First identify the supply and exhaust points in the car park. A system that complements the natural air path and is able to circulate or move air effectively within the car park should be chosen. Certain layout features may assist the effectiveness of a particular layout as shown below:

(a) 'Natural air path'

- For 'Linear Flow Systems', supply and exhaust points should be spaced across the length of a car park.
- 'Circular Mixing Systems' are more tolerant of closely placed supply and exhaust points, but it is advisable to have a good amount of separation.
- Supply air points should include access ramps to outside.
- The ventilation system layout should complement the natural air path from supply to exhaust points.

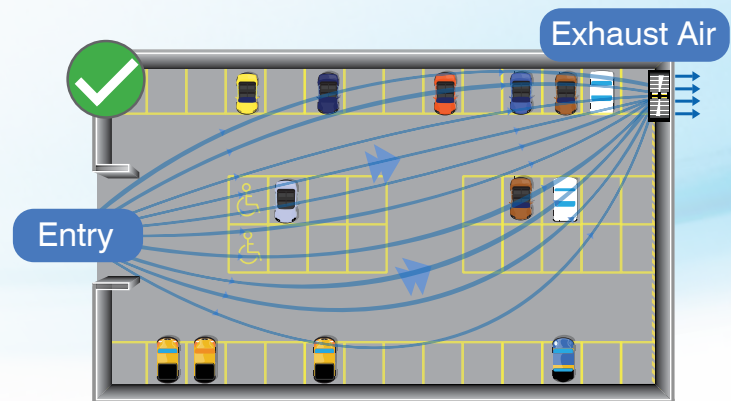

Preferred natural air path

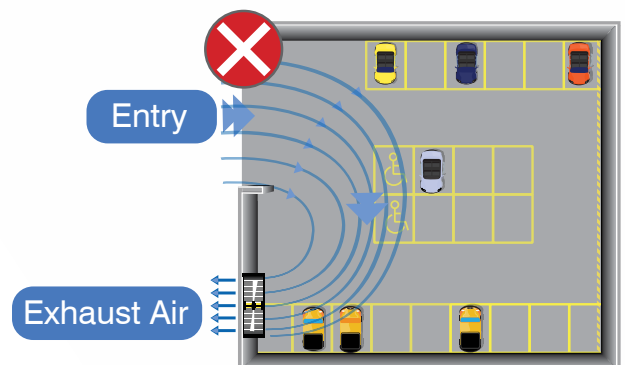

Natural air path to be avoided

(b) Ceiling features

To make the system more effective, position JetVent Fans in-line with supporting ceiling beams. If this is not possible, the system becomes less effective and more fans may be needed.

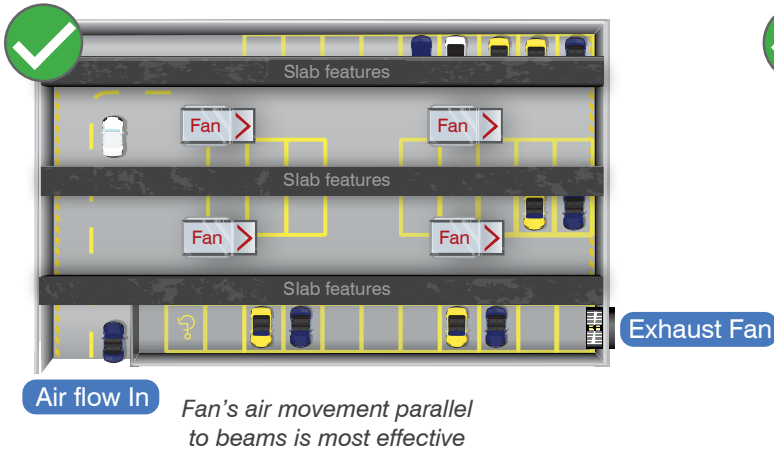

(c) Vertical clearance

Sufficient vertical clearance ensures maximum flexibility in system design. JetVent Fans may be recessed between ceiling beams to minimise the height of the system.

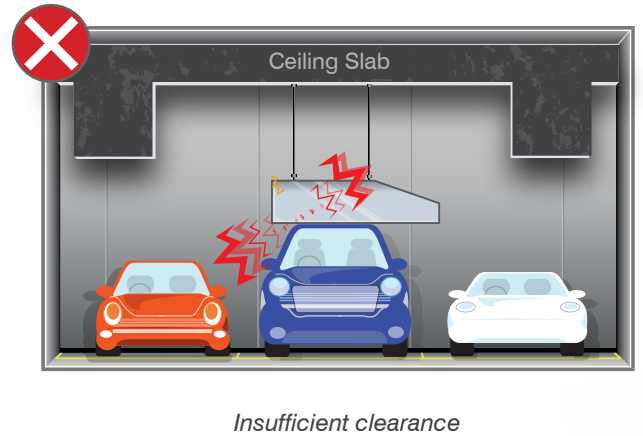
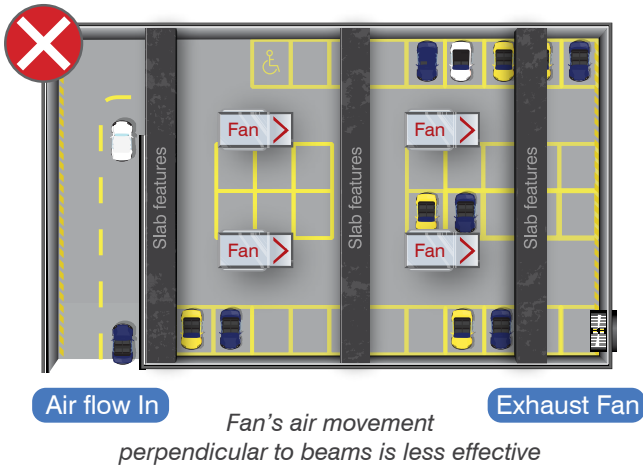
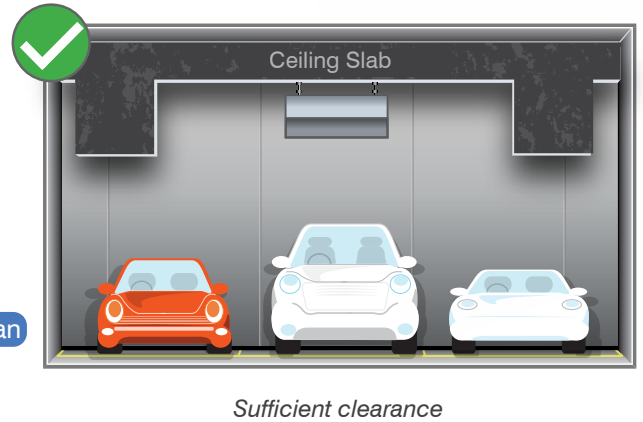

(d) Obstructions

If there is no option and the JetVent Fans must blow across ceiling beams, they have to be positioned a sufficient distance away from the obstruction. A horizontal distance eight times (8x) the height of the obstruction is generally sufficient. Nozzles on the JetVent units are specially designed and angled downwards for this purpose.

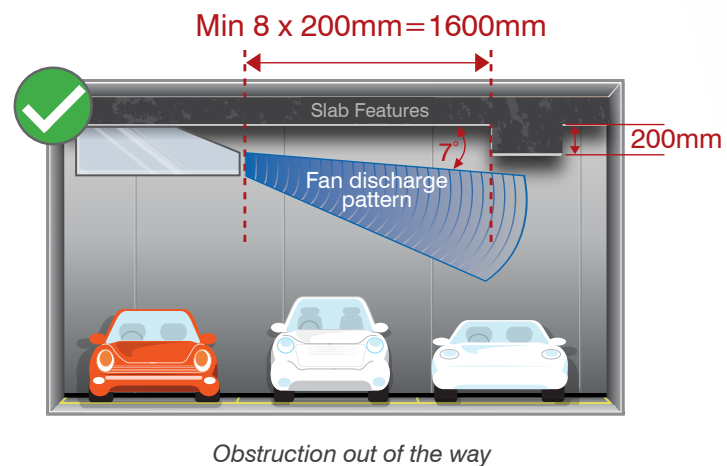
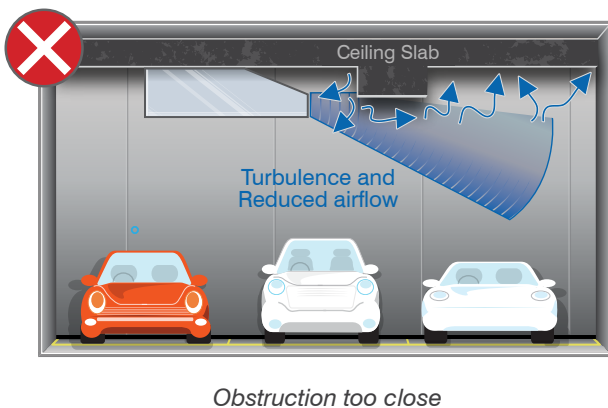

(e) Clashes with other services

Place mechanical service components, such as sprinklers, signs and pipework out of the JetVent's discharge pattern area.



An example of how to avoid clashes with pipework



Signs can impede fan throw

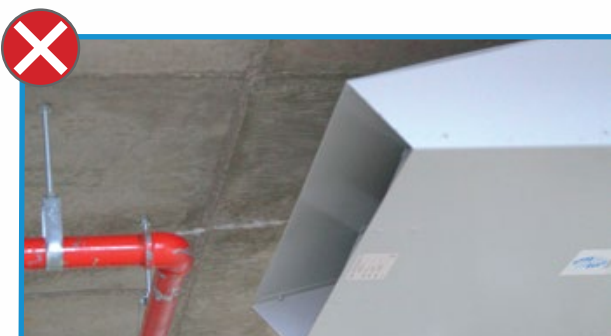

Pipework can impede fan throw

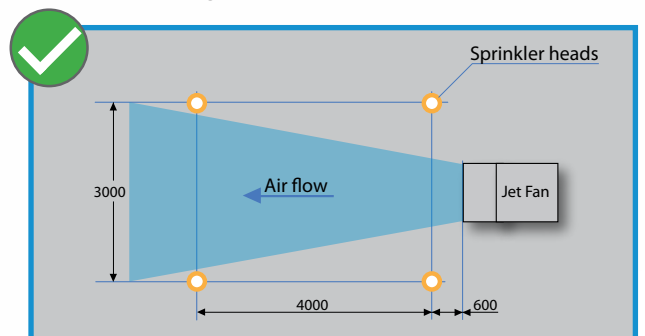

Jet fan layout in relation to sprinkler heads.

Step 2 Identify Fan Selection and Spacing

This table shows the maximum and recommended spacings between JetVent Fans for different levels of fan thrust. These spacing distances are guidelines for fans placed in series. When using these spacings, air velocities in most of the ventilated areas should be greater than 1m/s. AFCD analysis will determine whether this is achieved in a particular car park design. In some ideal cases, designs using the maximum distances have been effective.

Fan thrust depends on the operating speed of a particular fan unit and its thrust rating.

JetVent Selection

Step 1

Select the EC JetVent fan model based on their recommended spacing/coverage and the space needing to be ventilated.

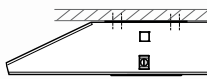
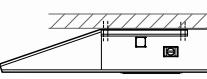
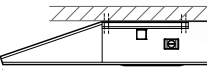
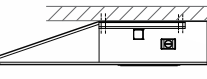
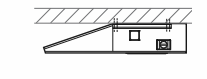
Operating Fan Thrust	Recommended Fan Spacing*	Maximum Fan Spacing	Recommended Coverage*	JetVent Code
48.2N	50m	60m	1000m ²	 JIU-CPCEC-HP
36.5N	35m	46m	730m ²	 JIU-CPCEC-USD
28.4N	30m	40m	560m ²	 JIU-CPCEC-SD
18.9N	25m	33m	430m ²	 JIU-CPCEC-LH
23.0N	20m	27m	350m ²	 JIU-CPCEC-ULH

Step 2

Select Isolator and Smoke Detection Kit



ISOLATOR KIT

HP, USD, SD, LH JetVent Models

Code: JIU-ISOLATORKIT

ULH JetVent Model

Code: JIU-ISOLKIT-ULH



SMOKE DETECTOR KIT

HP, USD, SD, LH JetVent Models

Code: JIU-SMOKEKIT

ULH JetVent Model

Code: JIU-SMOKEKIT-ULH

*Recommended Spacing & Coverage figures are to be used as a design guide only and are subject to variance with respect to car park usage type, supply/exhaust rates and car park geometry. Final spacing will be confirmed via CFD analysis.



After a preliminary fan layout is completed using the spacing distances above, the layout may be checked for total installed thrust. Successful designs typically have approximately 5N of thrust per 100m² of car park floor area. This thrust ratio also works well for estimating purposes.

Note that using higher rated JetVent fans generally makes the system more cost effective than using more lower rated fans. This is due to the requirement of less JetVent fans and hence saving on capital costs, installation costs and running costs. However, to effectively ventilate car parks with low ceiling heights, unusual or irregularly geometries, selecting more fans with smaller thrust ratings may be necessary.

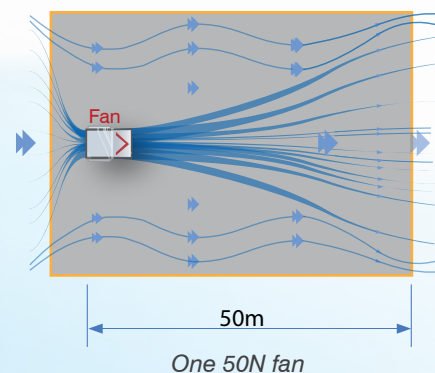
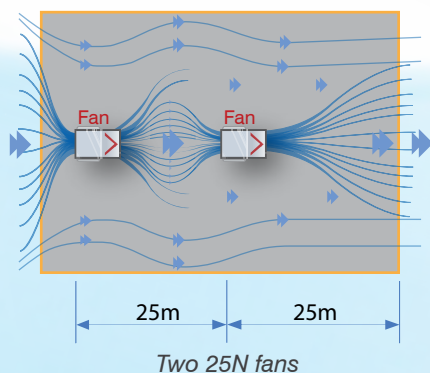

Step 3 - Design Example

For the purpose of estimating costs, the steps below may be bypassed. Allow 5N of thrust per 100m² of car park floor area to approximate the number of fans required.

Fans should be placed in the laneways with the air blowing along them. This is to avoid obstructions such as parked cars and also ensure that the throw pattern of the selected fan is long enough to reach the next JetVent fan.

JetVent Design Parameters;

- Based on 5N per 100m² floor area, minimum total fan thrust = car park floor area x 5N/100m²
= 1920m² x 5N/100m²
= 96N
- Minimum thrust criteria can be achieved with 4 x JIU-CPCEC-SD fans on preset speed (operating thrust 28.4N), total fan thrust = 28.4N x 4 = 113.6N.
- Fans are spaced within the 35m spacing recommendation for thrust levels.
- Final fan to wall spacing under 40m maximum spacing guide lines for fan thrust. This is because the exhaust point is an area of low pressure, making it likely to enhance the fan throw distance.

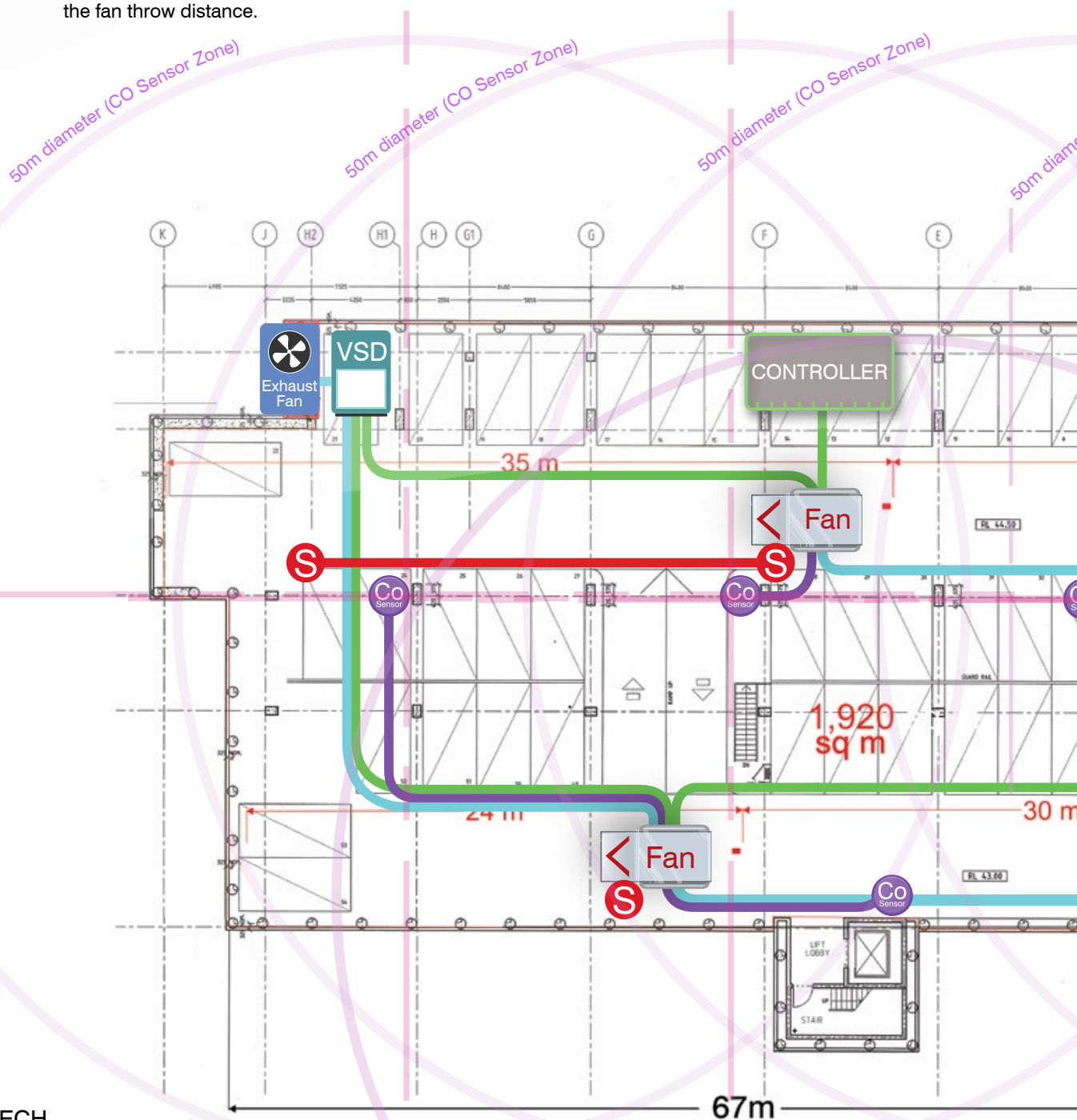

ComLink Design Parameters

Aviator controls should be placed in the Mechanical Services Switchboard enclosure. The RS485 ComLink line must start at the controller and then daisy chain to all the JetVent Fans and Drives. The last connection must have an End-of-Line resistor. If the line is greater than 1,000m or includes more than 32 connected devices, then a communications repeater must be added to extend the line. A repeater can also be used where the ComLink line branches off, such as at the beginning of each level in a multi-story car park.

Fantech can provide support for electrical cabling mark-up designs, to help ensure the most efficient ComLink strategy is used.

Placement of CO sensors:

Because the guidelines for positioning CO sensors in AS1668.2:2012 is based on a ducted system, we propose that the following guidelines be used as a starting point for their placement in a jet fan system.

1. No part of the enclosure shall be greater than 25 metres from a sampling point.
(A 50 metre diameter circle around a CO sensor can show coverage areas).
2. Additional detectors shall be installed in areas where people may congregate within the car park and are not within separately ventilated areas.
3. The most practical mounting position for a CO sensor within a car park is the support columns.
4. CO sensors will be more effective if placed in areas where CO levels are likely to be higher. Eg. Placing a CO sensor in front of a fresh air intake is not likely to be effective.

If jet fans are placed in each laneway of a car park and the recommended preset speed jet fan spacings are followed, the above guidelines can be achieved by using one CO sensor per jet fan and providing additional CO sensors at congregation points. Therefore, for this car park we would suggest installing 5 (4 + 1) CO sensors for good coverage.

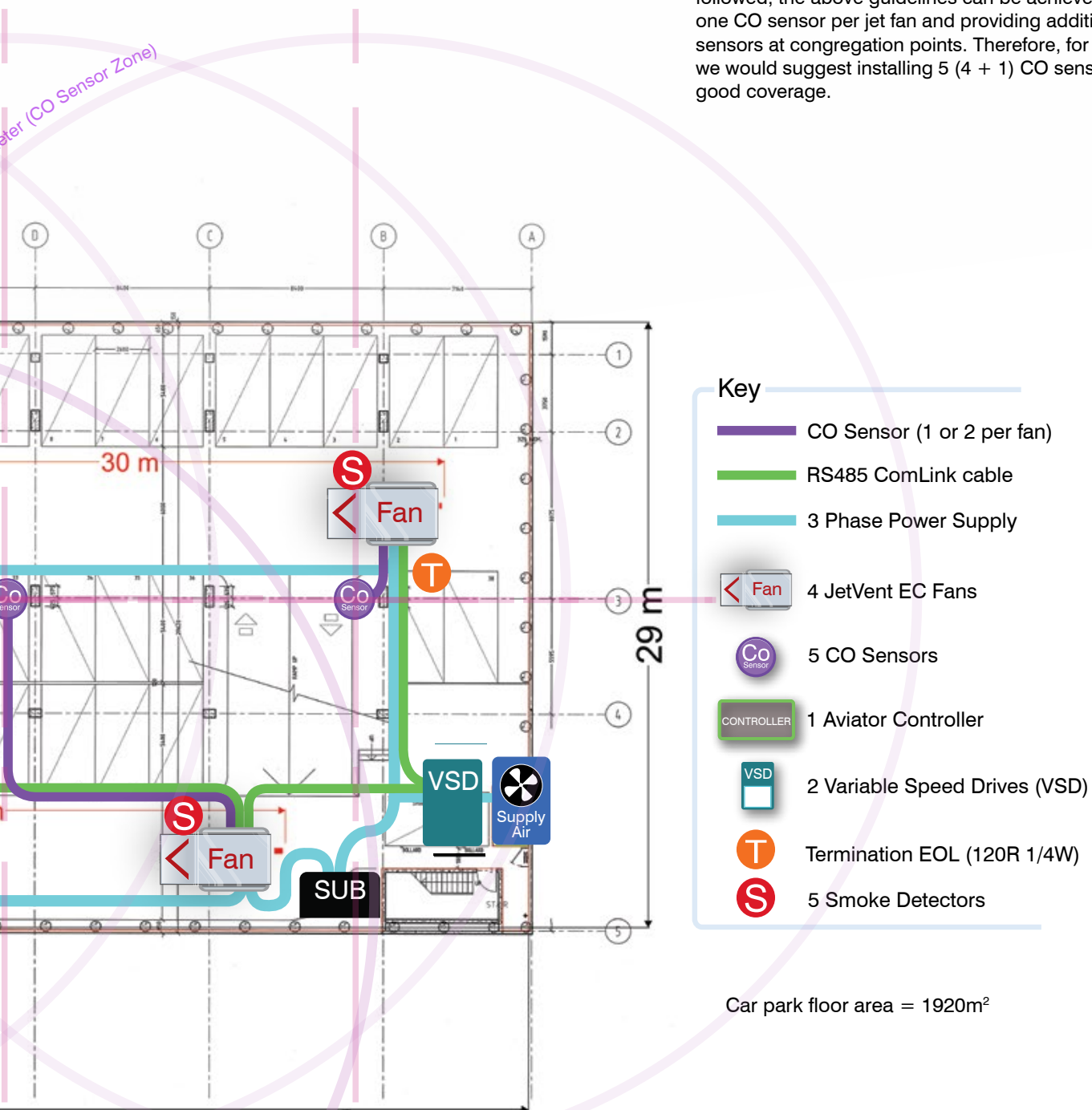

Car park floor area = 1920m²

Step 4 - Calculate Supply & Exhaust Rates

Section 4 of AS1668.2:2012 details requirements for ventilating car parks. In particular, sub-sections 4.4.3 and 4.4.4 of the standard outlines calculations of exhaust rates. In any of the two cases below, the exhaust air flow rate for a car park is taken as the greatest of the following calculations:

Calculation of exhaust air flow rates (L/s)	
Car parks with more than 40 spaces	Car parks with less than or equal to 40 spaces
a) $2000 \times F \times T$ (minimum air quantity for one operating car)	a) 2000
b) $0.85 \times P \times (100 \times n_1 + n_1 \times d_1 + n_2 \times d_2) \times E \times T$	b) $2.5 \times A$
c) $2.5 \times A$ (minimum air quality based on area of car park)	c) $400 n_1 \times P$

Supply air flows should range from 75% to 90% of the exhaust air quantity. This is based on the pressurisation of the car park, which should be 12Pa maximum.

Reference information for the calculation of exhaust air flow rates in the table above:

- A = the area of the zone or level, in square metres
- d_1 = the average driving distance, in metres, within the zone or level under consideration for the exit of a car parked there (see Clause 4.4.4.1)
- d_2 = the average driving distance, in metres, within the zone or level under consideration for the exit of a car whose exit route passes through the zone or level under consideration, but excluding any part of the exit route designated as queuing areas and ventilated in accordance with Clause 4.6 (see Clause 4.4.4.1)
- E = the staff exposure factor determined from page 38/39
- F = the staff usage factor determined from page 38/39
- n_1 = the number of parking spaces in the zone of level under consideration (see Clause 4.3.2)
- n_2 = the number of parking spaces situated in other parts of the car park, having exit routes passing through the zone or level under consideration
- P = the parking usage factor determined from page 38/39
- T = the vehicle type factor determined from page 38/39

If the car park has significant queuing areas for vehicles, refer to section 4.6 in AS1668.2:2012

Step 5 - Select the Aviator Control System

The Aviator Control System is a tailored solution, designed to efficiently manage car park ventilation equipment. It helps maintain good air quality when the car park traffic is high and conserve energy when it is low.

Overview

The Aviator Control System works in conjunction with the JetVent fans, CO and NOx pollutant sensors, variable speed drives, supply and exhaust fans and the BMS. The Aviator has been developed to help increase the energy efficiency of a car park, while ensuring the ventilation output is optimised. It will vary the operating speed of the car park fans according to when the requirements and demand in the environment develop.

When the CO or NOx pollutant levels within the car park reach a pre-set level, the ventilation fans begin to ramp up in speed. As the levels increase and decrease during the course of the day and night, the speed of the fans and therefore the ventilation rate also increase and decrease.

The Aviator Control System can also be connected to the fire system in the building to manage the automatic starting/stopping of the fans when a fire is detected (depending on fire/smoke management strategies), and control the fans at the FDCIE by manual speed control. Some buildings also require links from the Building Management System (BMS) to monitor the operation of the JetVent system in the car park.

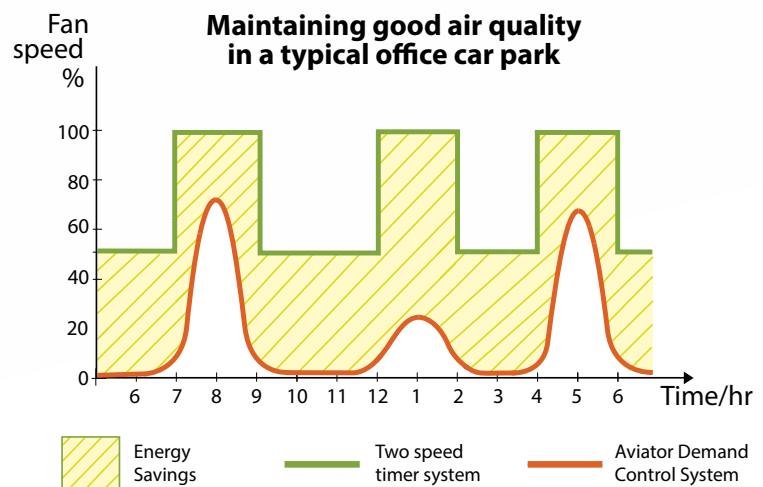

Step 5 - Select the Aviator Control System

	Description	Product Code
1 Select the controller	Aviator Max	DCV-CU-MAX1
	Aviator Mini	DCV-CU-MINI1
2 Select the BMS connection	Via Modbus TCP or RTU	N/A (std on controller)
	Via BACnet MSTP or IP	DCV-CPCO-LICENSE
3 Select the required sensors	4-20mA CO	DCV-LPT-TCO
	4-20mA NOx	DCV-LPT-END
	4-20mA Temperature	DCV-RHP-3S11
	Modbus RTU CO	DCV-GSTC-C
	Modbus RTU NOx	DCV-GSTC-N
	Modbus RTU Temperature	DCV-CDTA-2N000
4 Select the required accessories	Touchscreen 7" GUI	DCV-CU-GUI7TS
	Touchscreen 4.3" GUI	DCV-CU-GUI
	Expansion Module (Max Only)	DCV-CU-EXPENSION1
	Modbus Repeater	DCV-CU-REPEATER1
	Smoke Sensor	JIEC-SMOKESENSOR
	Smoke Ceiling Base Plate	JIEC-SMOKEBASE



Step 6 Installation

JetVent Fans are typically hard mounted to the concrete ceiling of the car park using 8mm fixing bolts. In some cases, fans may be set off the ceiling through the use of brackets and anti-vibration mounts. This may be the case if there are unavoidable obstructions near the discharge air stream. To maintain the building's structural integrity, methods of affixing fans may need to be approved by a structural engineer.

In general, vibration isolation is not required when installing JetVent Fans in retail or commercial office car parks. However, anti-vibration mounts may be required for installations underneath residential buildings or floor structures that are flexible or vibration sensitive. An isolation efficiency of 90%, or as otherwise specified by the design consultant, would be recommended.

Step 7 Commissioning the System

The following points are guidelines given regarding the procedure for commissioning a JetVent Car Park Ventilation system:

- 1 Check that the Aviator controller status says "System Ok". If this occurs then all the fans and sensors are connected correctly. If not please follow the trouble shooting manual.
- 2 Use the override feature in one of the sensors to activate all of the fans accordingly. Check all the fans are operating.
- 3 For further information please refer to the controller's installation and commissioning manual.

Step 8 Maintenance

- 1 Due to differing periods of operation, recommended inspection and maintenance periods may vary. It is suggested that inspection and, if necessary, fan cleaning (with non-abrasive cleaner) is carried out at regular intervals of 5000 running hours or 12 months, whichever comes first.
- 2 All mounting fasteners, should be checked for tightness within 4-6 weeks of commissioning and periodically thereafter.
- 3 JetVent fans use bearings that are "sealed-for-life" and do not need re-greasing. The motor's cleanliness must be checked to ensure overheating from dirt and dust build-up does not occur.
- 4 If possible visually check to make sure that the fans rotating components are not touching any other parts of the fan.
- 5 The Pollutant Sensors and Smoke Detectors should be typically checked and calibrated once every 12 months. Check your local requirements.



System Compliance

BCA Framework

In order to comply with the Building Codes of Australia (BCA), a building solution must satisfy the performance requirements as outlined in Part A2 of NCC 2019 Building Code of Australia - Volume One or latest version.

This can be achieved by:

- a) Complying with the “Deemed-to-Satisfy” provisions in the BCA, or
- b) Formulating a performance solution that complies with performance requirements or is shown to be equivalent to the Deemed-to-Satisfy provisions in the BCA.

For car park ventilation, the current “Deemed-to-Satisfy” requirements as outlined in the BCA requires a ventilation system complying with AS1668.2:2012 and AS/NZS1668.1:2015 or system complying with 1668.4 2012.

Australian Standard Requirements

AS1668.2:2012 is the current Standard relevant to ventilation of buildings as referenced in the BCA. As per this standard, the target of a car park ventilation system is to limit Carbon Monoxide (CO) concentrations to levels specified in Worksafe and National Health and Medical Research Criteria (NHMRC).

Under AS1668.2:2012 jet fans can be used to meet the Deemed-to-Satisfy provisions of the BCA.

Clause 4.4.2(c) of AS1668.2 2012 is intended to apply to situations where 1 or 2 jet fans are serving a dead spot in a car park. This concept is also mirrored in AS/NZS1668.1:2015 Section 5.5.1. Where the installation falls outside of these guidelines in particular when jet fans are arranged in series, the system is no longer considered Deemed-to-Satisfy and it is recommended that an mechanical and fire performance solution should be performed.



BCA Performance Clauses

An Independent Statutory Body has agreed that the relevant performance requirements applicable to jet fans are EP1.4, EP2.2 and FP4.4 of BCA2019 (where jet fans are outside of the Deemed-to-Satisfy requirements). The most common method of proving compliance is by performing a performance solution.

If a performance solution is required, a report will need to be submitted to the relevant approval authority to show that compliance with Performance Requirements EP1.4, EP2.2 and FP4.4 are achieved. These performance requirements are shown below.

BCA2019 EP1.4

An automatic fire suppression system must be installed to the degree necessary to control the development and spread of fire appropriate to --

- (a) the size of the fire compartment; and
- (b) the function or use of the building; and
- (c) the fire hazard; and
- (d) the height of the building.

Guidance:

In practical terms, the impact on sprinkler activation times should be minimised. This can be achieved with careful placement of jet fans in relation to sprinkler heads and by ensuring that jet fans are shut down prior to predicted sprinkler activation for the specific car park.

Sprinklers must be installed as per the BCA and AS 2118.1:2017. Fast response sprinkler heads may be an option to ensure activation times are minimised.

Note: If jet fans are shut down by smoke detection prior to sprinkler activation, activation times due to jet fan interaction become largely irrelevant. However, rapid sprinkler activation times with jet fans operating are still desirable as they may be considered a redundancy in the event that the smoke detection system fails.

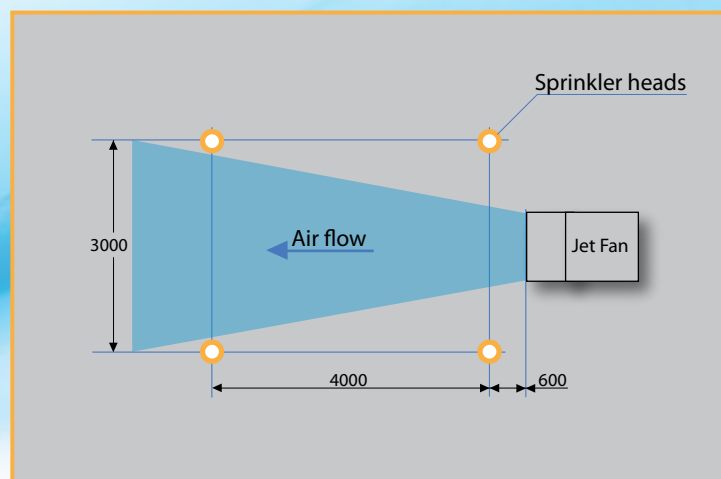

Example of Jet fan layout in relation to sprinkler heads.

System Compliance

BCA2019 EP2.2

- (a) In the event of a fire in a building the conditions in any evacuation route must be maintained for the period of time occupants take to evacuate the part of the building so that --
- (i) the temperature will not endanger human life; and
 - (ii) the level of visibility will enable the evacuation route to be determined; and
 - (iii) the level of toxicity will not endanger human life.
- (b) The period of time occupants take to evacuate referred to in (a) must be appropriate to --
- (i) the number, mobility and other characteristics of the occupants; and
 - (ii) the function or use of the building; and
 - (iii) the travel distance and other characteristics of the building; and
 - (iv) the fire load; and
 - (v) the potential fire intensity; and
 - (vi) the fire hazard; and
 - (vii) any active fire safety systems installed in the building; and
 - (viii) fire brigade intervention

Guidance:

Compliance with the BCA is fully achieved by complying with the Performance Requirements. Therefore showing compliance with Performance Requirement EP2.2 for a car park ventilation system demonstrates compliance with the BCA without the need to consider alternative Deemed-to-Satisfy requirements such as an AS1670.1 jet fan smoke detection system.



BCA2019 FP4.4

A mechanical air-handling system installed in a building must control --

- (a) the circulation of objectionable odours; and
- (b) the accumulation of harmful contamination by micro-organisms, pathogens and toxins.

The most comprehensive way of demonstrating this is by building a Computation Fluid Dynamics (CFD) Model of the car park. The model has to simulate pollution and air flow movement within the car park to ensure that Carbon Monoxide levels meet the requirements outlined above. While this approach is precise and ensures that the designed system works throughout the car park, it may be unnecessary for smaller car parks and those partially served by natural ventilation.

In these cases, 'expert judgement' or knowledge gained from projects completed previously may indicate that a proposed car park ventilation design using JetVent Fans will be adequate. Having defined the scenario for assessing the performance of the car park system, there are a number of ways of proving that the ventilation design performs adequately. AS1668.2:2012 contains information that will assist in the formulation of an alternative design. In order for the JetVent system to be approved as a performance design solution under AS1668.2:2012, it will need to be demonstrated that CO concentration levels between 750mm and 1800mm above the floor are limited to:

- (i) 60ppm 1hr maximum average
- (ii) 100ppm peak value; and
- (iii) 30ppm Time-Weighted-Average (TWA) over 8hrs

These guidelines are derived from Appendix N of AS1668.2:2012. The 60ppm 1hr maximum average is taken to be the significant design criteria. This is because guidelines in AS1668.2:2012 regarding the pollution levels of cars and maximum traffic scenarios work on the basis of a 'worst case condition' of one hour in duration. Also, if this is met, it is safe to say that CO levels will be well under the 100ppm peak values allowed in the standard.

The 30ppm time weighted average appears to apply to car parks where people work within the confines of the car park without having separate ventilation systems for their work area. Examples of this include car parks with a car wash inside or parking attendant booths with no other sources of ventilation. In most cases, the third CO concentration criteria will not apply to the car park due to the lack of these features.

Additional Guidance

This document provides information on how to show compliance with the BCA. In addition to this, various state fire authorities and the national body A.F.A.C. have released guidelines to further assist fire engineers and certifying authorities. Fantech recommend that these documents are also used to identify any additional local requirements.

Computational Fluid Dynamics (CFD) Analysis

Computational Fluid Dynamics (CFD) is the use of computer-generated models to simulate the aerodynamic behaviour around objects within a space. When performance solutions are proposed, as outlined on page 35 of this guide, a CFD analysis is a good method to demonstrate to approving authorities that the system is likely to perform satisfactorily. In order to successfully perform a CFD analysis, the following information is required:

- 1 Mechanical and architectural drawings are required in AutoCAD format with the locations of any obstructions to air flow, such as support columns, included. These drawings must also display plan views and elevations with detailed cross-sections to illustrate floor and ceiling heights.
- 2 Exhaust and supply air flow rate calculations provided by the consulting engineer.
- 3 Exhaust and supply air outlets/inlets are clearly marked on the drawings with all relevant dimensions and details shown.
- 4 Parameters for CO calculation are to be supplied correctly as per Clause 4.4.4.1 of AS1668.2:2012. This includes the number of cars, traffic paths and relevant parameters as per the standard. Another option is for the consulting engineer to clearly state an alternative international standard to be used for calculation purposes.
- 5 The JetVent Fan type, model and control method is clearly stated and indicated.
- 6 The target criteria for the CFD model is to be confirmed, e.g. 60ppm 1hr maximum average as per Australian Standards, along with the steps in the methodology.
- 7 Any additional views or plots required by the analysis are noted for inclusion in the CFD report.



CFD plot with velocity vectors, scale in m/s

The final CFD report should include a detailed description of the ventilation system with placements of JetVent fans illustrated on the drawings. The design criteria and objectives of the analysis need to be clearly detailed at the beginning of the report.

The report should also include the scenarios investigated along with air velocity and CO plots. These results closely reflect what would occur in the car park during real life situations. Figures 15 and 16 provide examples of typical CFD plots for air velocities and CO concentration levels respectively.

Fantech are able to facilitate a CFD analysis for you.

The cost of a CFD analysis is generally expected to be minimal in comparison with the potential cost savings associated with implementing the ventilation system. The time required to perform the analysis and supply the report varies greatly but is usually between 2-6 weeks.

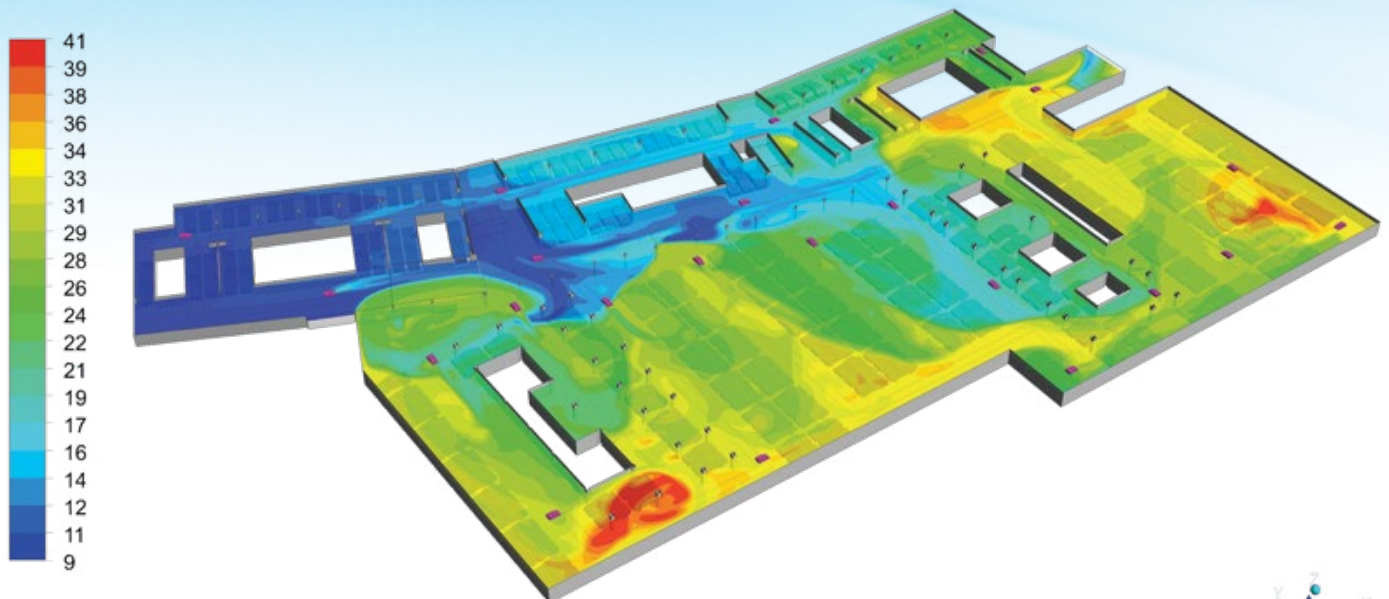

CFD plot of CO concentration levels, scale in ppm



References

Australian Building Codes Board 2013, *NCC 2019 Building Code of Australia - Volume One*

British Standards Institution 1999, *Fans for general purposes. Methods of noise testing (BS 848-2 – 1985)*, British Standards, London.

Standards Association of Australia 2015, *methods of test and rating requirements for smoke-spill fans- (AS 4429 – 1999)*, Standards Australia, Sydney.

Standards Association of Australia 1998, *The use of ventilation and air-conditioning in buildings Part 1: Fire and smoke control in multi-compartment buildings (AS/NZS1668.1:2015)*, Standards Australia, Sydney.

Standards Association of Australia 2012, *The use of ventilation and air-conditioning in buildings Part 2: Ventilation design for indoor air contaminant control (AS 1668.2 – 2012)*, Standards Australia, Sydney.

The use of ventilation and airconditioning in buildings Natural ventilation of buildings (AS 1668.4 - 2012).

Automatic fire detection and alarm systems (AS1670.1).

Automatic fire sprinkler systems General systems (AS 2118.1 - 2017).

Acoustics - Recommended design sound levels and reverberation times for building interiors (AS/NZS 2107 - 2000).

Appendix

AS1668.2 - 2012 Calculation Factors

1 Parking Usage Factor (P)

Use of car park	Parking usage factor (P)
Residential	0.3
Commercial	0.5
Retail/food and drink services	0.7
Entertainment/sports centres	1.0
Vehicle Depots	2.4

2 Vehicle Type Factor (T)

Use of car park	Vehicle type factor (T)
No special vehicle population	1.0
Diesel vehicles	2.4
LPG vehicles	1.0
CNG vehicles	1.0
Electric powered vehicles	0.1
Motorcycles	0.25

3

Staff Usage/Exposure Factor (E & F)

Parking procedure	Staff exposure factor (E)	Staff usage factor (F)
No special procedures (self-parking), any staff in separate enclosure ventilated in accordance with Clause 4.2.2	1	1
Self-parking stack parking, any staff in separate enclosure ventilated in accordance with Clause 4.2.2	1	$1 + 0.1 \times \text{No. of car spaces without immediate access to driveway}$
No special procedures (self-parking), staff located in car parking enclosure	1.8	2
Self-parking stack parking, staff located in car parking enclosure	1.8	$2 + 0.25 \times \text{No. of car spaces without immediate access to driveway}$
Attendant parking no stack parking	1.8	$2.5 \times \text{No. of attendants}$
Attendant parking stack parking	1.8	$3.5 \times \text{No. of attendants}$
Mechanical stack parking	1.8	$2 \times \text{No. of car engines operating at any one time}$



Australia

Adelaide (08) 8294 0530

Brisbane (07) 3299 9888

Canberra (02) 6280 5511

Darwin (08) 8947 0447

Hobart (03) 6273 6455

Melbourne H.O. (03) 9554 7845

Newcastle (02) 4961 6088

Perth (08) 9209 4999

Sydney (02) 8811 0400

Townsville (07) 4775 5222

Wollongong (02) 4226 5133

New Zealand

Auckland H.O. (09) 444 6266

Christchurch (03) 379 8622

Wellington (04) 566 0532

Visit our website at www.fantech.com.au