

It has never been easier to take control of your indoor air quality

90%

We spend **90% OF OUR TIME INDOORS** and indoor air can be 5x more polluted than outdoor air.

86%

86% of employees rank indoor air quality as one of the most important factors to **WORKPLACE COMFORT**.

Poor indoor air quality

is linked to poorer health, lower productivity and may be a sign of wasted energy.

Airthings for Business helps you:

- Monitor, measure and analyze indoor air quality of multiple buildings in one place
- Improve the health, safety and wellbeing of occupants
- Directly impact productivity and reduce sick leave
- Reduce energy usage by optimizing HVAC based on use of building
- Automatically run your building management system based on real-time air quality data via API.



Ideal for

- Offices
- Medical facilities
- Educational institutions
- Gyms and sports facilities
- Commercial buildings
- Retail shops
- Restaurants and hotels











The Airthings for Business solution

An easily scalable solution that works for buildings of any type and size.

- Easy installation and setup
- Works for all buildings
- Battery-powered & wireless monitors
- Ideal for retrofitting
- “Out of the box” solution, no tools or expertise required
- Long battery life
- Customizable dashboard with displays and alerts
- Encrypted enterprise security from device to cloud
- Open API to integrate with Building Management Systems



Measuring key air quality factors

 RADON	 PM ₁	 PM _{2.5}	 HUMIDITY	 CO ₂
 VOC	 NOISE	 LIGHT	 TEMP	 PRESSURE

VIRTUAL SENSORS

 VIRUS RISK
 MOLD RISK



Get to know the Airthings for Business solution

Easily access sensor data through the **REST API** or subscribe with the Webhook. Use your sensor data in your existing BI solution or as an input to a BAS or BMS.

Airthings for Business Dashboard is easy to use and gives a detailed insight into how your building, office or school behaves. With access to historical data, you can start making informed decisions on how to improve the air you breathe. One-click reports for indoor air quality, radon, outdoor air quality and virus risk. Easily set up alerts to get notified for when you need to take action.

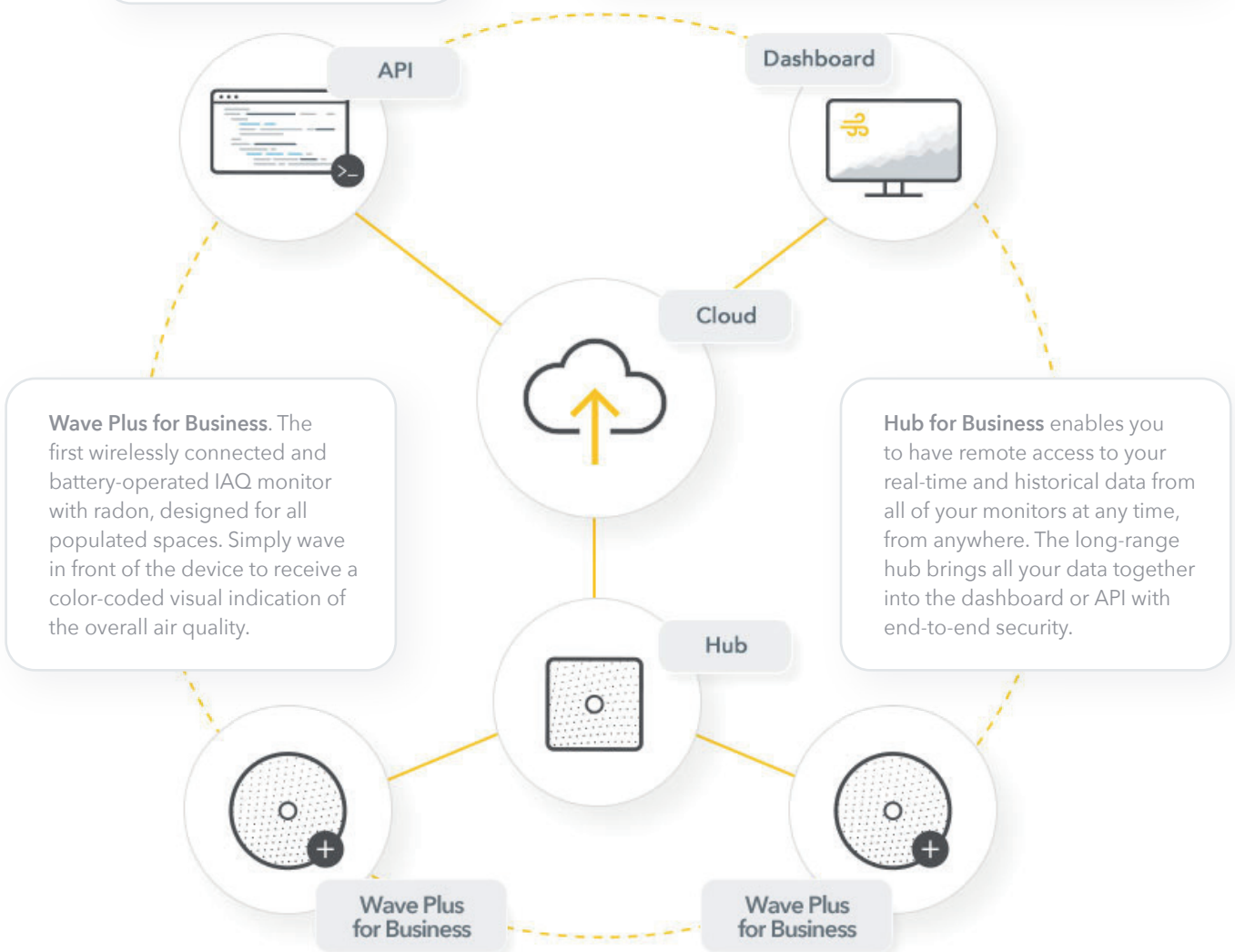

Wave Plus for Business. The first wirelessly connected and battery-operated IAQ monitor with radon, designed for all populated spaces. Simply wave in front of the device to receive a color-coded visual indication of the overall air quality.

Hub for Business enables you to have remote access to your real-time and historical data from all of your monitors at any time, from anywhere. The long-range hub brings all your data together into the dashboard or API with end-to-end security.

Airthings for Business



A complete and flexible air quality monitoring solution for any building

airthings.com/business

Airthings for Business allows businesses to monitor, measure and analyze their indoor air quality. Improving the health and wellbeing of a building directly impacts productivity and energy efficiency, be it an office building, residential block, medical facility or educational institution.

DASHBOARD AND API

The Airthings Hub connects your Airthings devices online. Access real-time data from all your devices from the Airthings Dashboard, or through the API or a Webhook. The Airthings Dashboard includes alerts, advanced analytics and reporting. In addition, easily view, compare and export data and receive tips to reduce indoor air hazards, optimize ventilation and save on energy costs.

Each Airthings for Business Subscription includes unlimited cloud storage of sensor data.

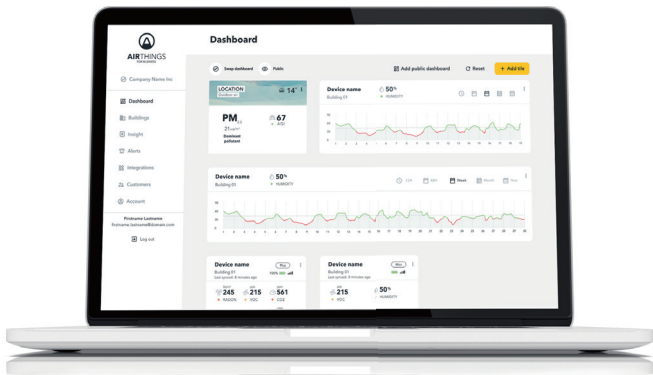

Hub for Business

The Hub for Business is an integral part of the Airthings ecosystem which collects data from in-range sensors and provides real-time access to all the information you need to optimize air quality in your building.



AIRTHINGS SMARTLINK

SmartLink is the Airthings proprietary long range and low power IoT protocol between Hub and Airthings devices. SmartLink connectivity can typically penetrate 3 thick walls/floors or 10 drywalls (non-loadbearing walls). Airthings devices will always connect to the closest Hub and additional Hubs can be installed to increase coverage. The mounting bracket allows for placing the Airthings for Business Solution products on a flat surface or fixing it with double-sided tape or screws to the wall.

PACKAGE CONTENT

- Airthings Hub for Business
- Ethernet cable
- Mounting bracket
- Rubber bumper pads (for flat surface)
- Double-sided tape (for wall mount)
- Power supply adaptor
- US interchangeable supply blade
- EU interchangeable supply blade
- UK interchangeable supply blade
- AU interchangeable supply blade
- Optional Power over Ethernet-splitter for combined power supply and ethernet connection.

PRODUCT CODES

- HUB CELLULAR, MODEL 2820
- EAN: 7090031108205
- SKU: 282
- Device serial number: 2820xxxxxx

PACKAGE

- Dimensions: 6.22 x 6.22 x 3.11 in (158 x 158 x 79 mm)
- HUB CELLULAR, MODEL 2820
- Weight: 20.2 oz (574 g)

REQUIREMENTS

- Dimensions: 5.12 x 5.12 x 0.98 in (130 x 130 x 25 mm)
- HUB CELLULAR, MODEL 2820
- Weight: 9.1 oz (258 g)
- Cellular connection with built-in eSIM or Ethernet connection.

PRODUCT DIMENSIONS

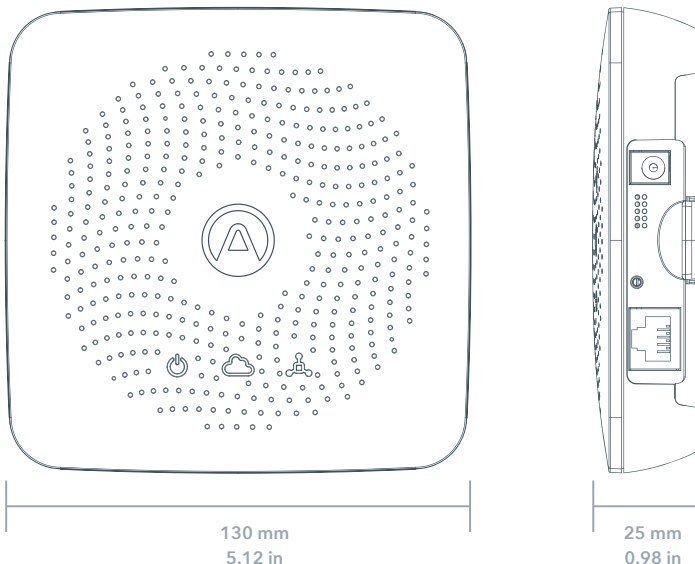

View Plus for Business



The most comprehensive indoor air quality monitor in the Airthings for Business solution, including PM, Noise and more. The View Plus for Business has an ultra low battery consumption customizable display. Can be seamlessly added into an existing Airthings for Business solution.

PACKAGE CONTENT

Airthings View Plus for Business
6 x Lithium AA batteries
Double-sided tape
Security mount
Optional USB cable 6 ft. (1.8 m) (5 pack)
Optional bracket for fixed power supply
Optional in-wall fixed power supply

MOUNTING

Supports wall mounting or placement on table. Optimum product placement is breathing height of 3 - 6 ft (110 - 170 cm) above floor. Only suitable for mounting at heights below 6.56 ft (200 cm). Double-sided tape for wall mount included in package. Alternatively use 3 screws of type countersunk M4 (not included).

PRODUCT FEATURES

Sensors: PM₁, PM_{2.5}, VOC, CO₂, Noise, Relative Humidity, Air Pressure, Temperature, Relative Light Intensity (0 - 100 %)
Battery life: Up to 4 years on Lithium (depending on the sensor interval settings)

REQUIREMENTS

Weight: 360 g (12.7 oz) with batteries
Dimensions: 6.69 x 3.54 x 1.30 in (170 x 90 x 33 mm)
Airthings Hub needed to post sensor values to cloud

PACKAGE

Dimensions: 7.9 x 4.5 x 2.4 in (200 x 115 x 60 mm)
Weight: 15.17 oz (430 g)

PRODUCT SPECIFICATIONS

Operational Environment (Temperature, Relative Humidity): 39 °F to 104 °F (4 °C to 40 °C) / 10 - 80 % (non-condensing)
Operation in temperatures < 32 °F (0 °C) or relative humidity > 90 % can cause permanent damage to the products
Firmware updates are automatically downloaded and installed over the air (OTA) via the Airthings for Business Hub
SmartLink frequencies: 865-868/902-928 MHz depending on region

PRODUCT CODES

Device serial number: 2969xxxxxx
US / CANADA EAN: 7090031109615
SKU: 961 Model: 2969
EUROPE EAN: 7090031109622 SKU: 962
SINGAPORE / HONG KONG
EAN: 7090031109639 SKU: 963
AUSTRALIA EAN: 7090031109646
SKU: 964
INDIA EAN: 7090031109653 SKU: 965



PM₁



PM_{2.5}



CO₂



VOC



TEMP



HUMIDITY



NOISE



LIGHT



PRESSURE



VIRUS RISK

View Plus for Business

SENSOR SPECIFICATIONS

Sensor sampling interval: 5 min.
View Plus offers in addition configurable sensor sampling intervals from 2.5 min to 60 min for selected sensors.
Technology for Temperature, Humidity and Pressure Sensors:

RELATIVE HUMIDITY SENSOR

Technology: Solid state sensor
Resolution: 0.5 %RH
Accuracy: ± 3 %RH at 77 °F (25 °C) within 20-80 %RH

TEMPERATURE SENSOR

Technology: Solid state sensor
Resolution: 0.1 °F (0.1 °C)
Accuracy: ± 0.9 °F at 77 °F / ± 1.8 °F from 32-140°F (± 0.5 °C at 25 °C / ± 1 °C from 0-60 °C)

PRESSURE SENSOR

Technology: Solid state sensor
Pressure Accuracy: ± 0.6 mBar/hPA (0.02 inHg) range 500-1100 mBar/hPA

VOC SENSOR

Technology: Metal-oxide based gas sensor
Measurement range: 0-10 000 ppb
Settling time: ~7 days

PARTICULATE MATTER PM₁ AND PM_{2.5}

Technology: laser scattering based optical particle counter
Particle size detection range: 300 nm to 10 μ m
Measurement Range: 1-1000 μ g/m³
Measurement Accuracy: below 150 μ g/m³: $\pm (5 \mu\text{g}/\text{m}^3 + 15 \%)$, above 150 μ g/m³: $\pm (5 \mu\text{g}/\text{m}^3 + 20 \%)$. Calibrated with a GRIMM reference instrument using cigarette smoke source.
Resolution: 1 μ g/m³
Classified as Class 1 Laser per IEC60825-1 Ed. 3. This device complies with 21 CFR 1040.10 and 1040.11, except for conformance with IEC 60825-1 Ed. 3., as described in Laser Notice No. 56, dated May 8, 2019. Caution: This device

contains one or more lasers. Use other than as described in the user guide, repair, or disassembly may cause damage, which could result in hazardous exposure to infrared.

CO₂ SENSOR

NDIR Sensor (Non-Dispersive Infra-Red):
Measurement range 400-5000 ppm.
Settling time: ~7 days
Accuracy ± 50 ppm ± 5 % at 400-2000 ppm within 50 - 95 °F (10 - 35 °C) and 0 - 80 %RH, after initial settling time of 7 days.
Resolution: 1 ppm

LIGHT SENSOR

Measurement range: 0 - 100 %

NOISE SENSOR

Dynamic range: 35 - 120 dBA SPL (optimization pending)

VIRUS RISK

Virtual sensor

RADIO SPECIFICATIONS

BLUETOOTH LOW ENERGY

Output power: <5 mW
Frequency Range (MHz): 2400.0 - 2483.5

AIRTHINGS SMARTLINK

Output power: <25 mW
Frequency range (MHz): Europe 868 - 870 North America 902-928

Singapore 920-923
Hong Kong 920-923
Australia 923-928
India 865-870

PRODUCT DIMENSIONS

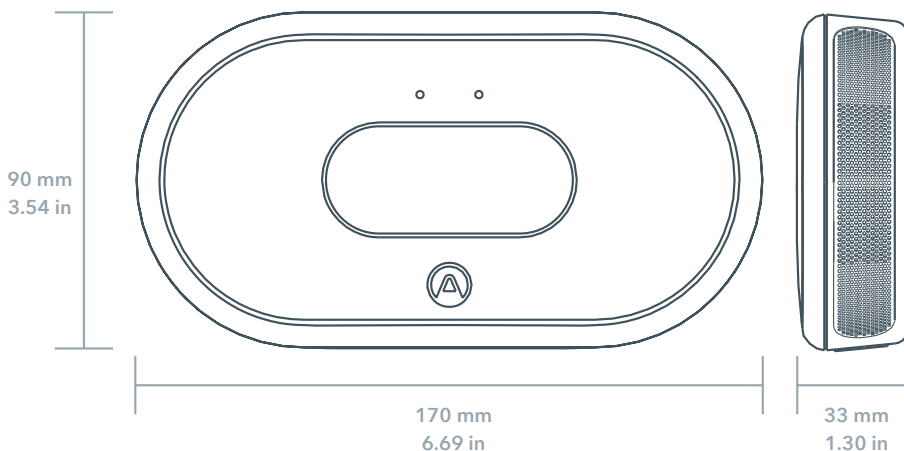

View CO₂ for Business



CO₂ monitoring made easy for any building, anywhere. The View CO₂ for Business has an ultra energy efficient customizable display. Can be seamlessly added into an existing Airthings for Business solution.

PACKAGE CONTENT

Airthings View CO₂ for Business
6 x Lithium AA batteries
Double-sided tape
Optional theft protection lid (5 pack)
Optional USB cable 6 ft. (1.8 m) (5 pack)

REQUIREMENTS

Weight: 360 g (12.7 oz) with batteries
Dimensions: 6.69 x 3.54 x 1.30 in
(170 x 90 x 33 mm)
Hub for Business needed to post sensor values to cloud

PRODUCT CODES

Device serial number: 2969xxxxxx
US / CANADA EAN: 7090031109615
SKU: 961 Model: 2969
EUROPE EAN: 7090031109622 SKU: 962
SINGAPORE / HONG KONG
EAN: 7090031109639 SKU: 963
AUSTRALIA EAN: 7090031109646
SKU: 964
INDIA EAN: 7090031109653 SKU: 965

MOUNTING

Supports wall mounting or placement on table. Optimum product placement is breathing height of 3 - 6 ft (110 - 170 cm) above floor. Only suitable for mounting at heights below 6.56 ft (200 cm). Double-sided tape for wall mount included in package. Alternatively use 3 screws of type countersunk M4 (not included).

PACKAGE

Dimensions: 7.9 x 4.5 x 2.4 in
(200 x 115 x 60 mm)
Weight: 15.17 oz (430 g)

PRODUCT FEATURES

Sensors: CO₂, Noise, Relative Humidity, Temperature, Relative Light Intensity (0 - 100 %)
Virtual sensors included:
Virus Risk Indicator
Battery life: Up to 10 years on Lithium (depending on the sensor interval settings)

PRODUCT SPECIFICATIONS

Operational Environment (Temperature, Relative Humidity):
39 °F to 104 °F (4 °C to 40 °C) / 10 - 80 % (non-condensing)
Operation in temperatures < 32 °F (0 °C) or relative humidity > 90 % can cause permanent damage to the products
Firmware updates are automatically downloaded and installed over the air (OTA) via the Airthings for Business Hub
SmartLink frequencies: 865-868/902-928 MHz depending on region



CO₂



TEMP



HUMIDITY



NOISE



LIGHT



VIRUS RISK

View CO₂ for Business

SENSOR SPECIFICATIONS

Sensor sampling interval: 5 min.
View CO₂ offers in addition configurable sensor sampling intervals from 2.5 min to 60 min for selected sensors.
Technology for Temperature and Humidity Sensors

TEMPERATURE AND RELATIVE HUMIDITY SENSORS

Temperature Accuracy: ± 0.9 °F (± 0.5 °C)
Humidity Accuracy: ± 3 %RH

CO₂ SENSOR

NDIR Sensor (Non-Dispersive Infra-Red):
Measurement range 400-5000 ppm
Settling time: ~7 days
Accuracy ± 50 ppm ± 3 % within 50 - 95 °F (10 - 35 °C) and 0 - 80 %RH, after initial settling time of 7 days

LIGHT SENSOR

Measurement range: 0 - 100 %

NOISE SENSOR

Dynamic range: 35 - 120 dBA SPL (optimization pending)

VIRUS RISK

Virtual sensor

RADIO SPECIFICATIONS

BLUETOOTH LOW ENERGY

Output power: <5 mW
Frequency Range (MHz):
2400.0 - 2483.5

AIRTHINGS SMARTLINK

Output power: <25 mW
Frequency range (MHz):
Europe 868 - 870
North America 902-928

Singapore 920-923
Hong Kong 920-923
Australia 923-928
India 865-870

PRODUCT DIMENSIONS

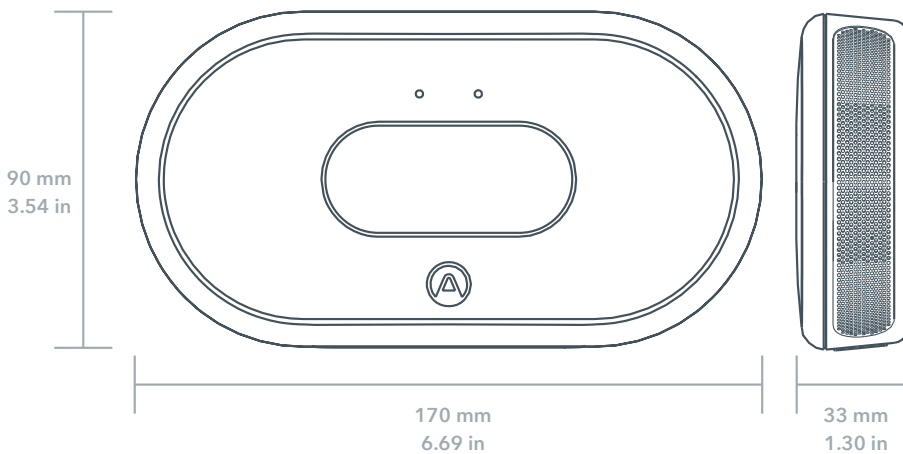

Wave Plus for Business

Wave Plus for Business gives full visibility into radon, carbon dioxide (CO₂), airborne chemicals and odors (VOCs), humidity, temperature, air pressure and light - seven key factors of IAQ. It's the ideal solution for employers, facility managers and schools.



PACKAGE CONTENT

Airthings Wave Plus for Business
2 Lithium AA batteries
Double-sided tape
Optional theft protection lid

MOUNTING

Supports wall mounting or placement on table. Optimum product placement is breathing height of 3 - 6 ft (110 - 170 cm) above floor. Only suitable for mounting at heights below 6.56 ft (200 cm). Double-sided tape for wall mount included in package. Alternatively use 1 screw of type countersunk M4 (not included)

PRODUCT FEATURES

Sensors: Radon, CO₂, VOCs, Temp, Relative Humidity, Air Pressure, Relative Light intensity (0 - 100 %)
Battery life: 1.5 years on Alkaline (2 years on Lithium)

REQUIREMENTS

Weight : 7.72 oz (219 g) with
2 x AA Lithium batteries
Dimensions: 4.72 x 1.42 in (120 x 36 mm)
Airthings Hub needed to post sensor values to cloud
HUB, MODEL 2810

PACKAGE

Dimensions: 6.02 x 6.02 x 1.81 in
(153 x 153 x 46 mm)
Weight: 12.2 oz (346 g)

PRODUCT SPECIFICATIONS

Operational Environment (Temperature, Relative Humidity):
Wave Plus: 39 °F to 104 °F (4 °C to 40 °C) / 10 - 80 % (non-condensing)
Operation in temperatures < 32 °F (0 °C) or relative humidity > 90 % can cause permanent damage to the products
SmartLink frequencies: 865-868/902-928 MHz depending on region
Firmware updates are automatically downloaded and installed over the air (OTA) via the Airthings for Business Hub.

PRODUCT CODES

US / CANADA

EAN: 7090031109318
SKU: 931
Device serial number: 2930xxxxxx

EUROPE

EAN: 7090031109325
SKU: 932
Device serial number: 2930xxxxxx



RADON



VOC



CO₂



HUMIDITY



TEMP



PRESSURE



LIGHT



VIRUS RISK

Wave Plus for Business

SENSOR SPECIFICATIONS

Sensor sampling interval:
5 min, except radon 60 min

RADON SENSOR

Passive diffusion chamber
Detection method: Alpha spectrometry
Measurement range: 0 - 20,000 Bq/m³
(0 - 5,405 pCi/L)
Long term measurement accuracy at
200 Bq/m³(5.4 pCi/L):
After 7 days ± 10 %, after 2 months ± 5 %

VOC SENSOR

Measurement range: 0-10 000 ppb
Resolution: 1 ppb
Settling time: ~7 days

CO₂ SENSOR

NDIR Sensor (Non-Dispersive Infra-Red):
Measurement range 400-5000 ppm
Resolution: 1 ppm
Accuracy: ±30 ppm ±3 % within 59 to
95 °F (15 - 35 °C) and 10 - 80 % RH can
be reached after multiple settling cycles
on locations with natural indoor CO₂
fluctuations
Settling time: ~7 days

RELATIVE HUMIDITY SENSOR

Technology: Solid state sensor
Resolution: 0.5 %RH
Accuracy: ±3 %RH at 77 °F (25 °C)
within 20-80 %RH

TEMPERATURE SENSOR

Technology: Solid state sensor
Resolution: 0.1 °F (0.1 °C)
Accuracy: ±0.9 °F at 77 °F / ±1.8 °F from 32-
140°F (±0.5 °C at 25 °C / ±1 °C from 0-60 °C)

PRESSURE SENSOR

Technology: Solid state sensor
Resolution: 0.02 mBar/hPA
Absolute accuracy: ± 0.6 mBar/hPA
Relative accuracy: ± 0.12 mBar/hPA
Measurement range: 500-1100 mBar/hPA

LIGHT SENSOR

Measurement range: 0 - 100 %

VIRUS RISK

Virtual sensor

PRODUCT DIMENSIONS

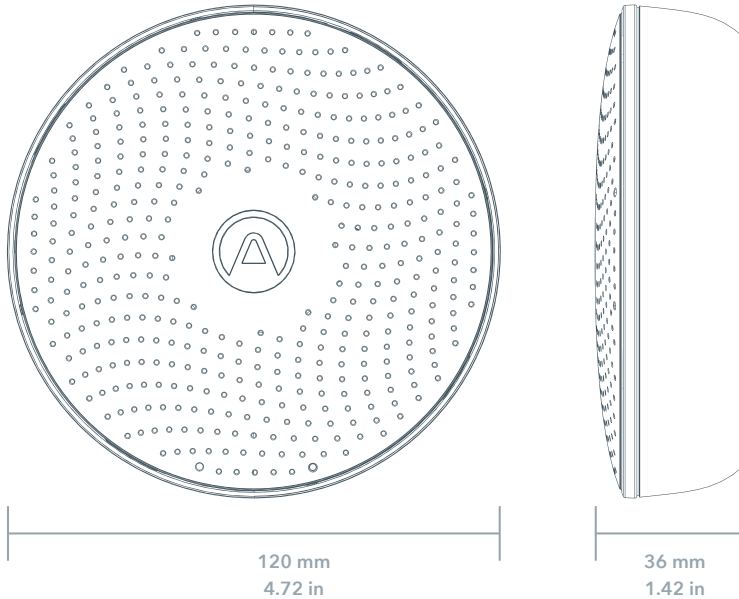



Fantech Pty. Ltd.

Victoria:	(+61 3) 9554 7845
New South Wales:	(02) 8811 0400
South Australia:	(08) 8294 0530
Northern Territory:	(08) 8947 0447
Queensland:	(07) 3299 9888
Western Australia:	(08) 9209 4999
A.C.T.:	(02) 6280 5511
Tasmania:	(03) 6273 6455
New Zealand:	(09) 444 6266

www.fantech.com.au |    

For sales enquiries contact:

Specifications and design subject to change without notice.

A MEMBER OF  ELTA GROUP